



**Description**

Power-One's high power modular products can be configured to provide up to 21 outputs in over 10 million voltage and current combinations. Eighteen chassis are available from 1000 to 4000 watts; including power factor corrected, three-phase input, and metric mounting hardware models. Over 90 output modules are available to provide voltages from 1 to 48VDC. Output modules have a field demonstrated MTBF of greater than 5 million hours. Other features include a comprehensive array of module and system interface signals, extensive input transient protection, and international regulatory agency approvals. These high-performance products have a proven track record in high reliability communications, semiconductor test, and industrial applications.

**Table of Contents**

Product Overview ..... 2

Modular System Overview and Selection ..... 4

Configuring a Power System ..... 5

DC Output Module Selection ..... 6

Paralleled Module Configurations ..... 8

DC Module Specifications ..... 9

Chassis Electrical Specifications ..... 11

Exceptional AC Input Transient Immunity ..... 15

DC Output Modules Demonstrated MTBF ..... 17

Modular High Power Mechanical Drawings (These may be downloaded from [www.power-one.com](http://www.power-one.com) by using the AC-DC Configurable Modular Link.)

NUCLEAR AND MEDICAL APPLICATIONS - Power-One products are not designed, intended for use in, or authorized for use as critical components in life support systems, equipment used in hazardous environments, or nuclear control systems without the express written consent of the respective divisional president of Power-One, Inc.

TECHNICAL REVISIONS - The appearance of products, including safety agency certifications pictured on labels, may change depending on the date manufactured. Specifications are subject to change without notice.

## PRODUCT OVERVIEW

### RELIABILITY

- Demonstrated DC output module MTBF of greater than 5 million hours.
- Ruggedized AC input sections incorporate extensive transient protection.
- Vibration tested at 6 GRMS, 3 axis, 10 to 2000 Hz.
- Two-year warranty.

### FLEXIBILITY

- Modular construction; over 10 million configurations available.
- Up to 21 outputs per power supply from 1.0 to 48 VDC.
- Parallelable outputs with current sharing.
- System inhibit and individual module output inhibit capability.
- Metric mounting available on selected models.

### PERFORMANCE

- Single outputs fully regulated and isolated.
- Active PFC models meet EN61000-3-2 and EN60555-2.
- EN60950/UL1950 approved. CE Marked to the Low Voltage Directive.
- No minimum loads required on most outputs.



### Modular High Power Series Product Overview

CHASSIS	METRIC MOUNTING STANDARD	SMF3 SPF3	HMF3 HPF3	HMF5 HPF5	SMM3 SPM3	SMM5 SPM5	HMM5 HPM5	HMM7 HPM7	RMF5 RPF5	RMM5 RPM5
<b>OUTPUT POWER AND POWER FACTOR</b>										
.99 PFC to meet EN60555		YES	YES	YES	N/A	N/A	N/A	N/A	YES	N/A
Max output wattage at high range line input		1350	2000	2000	1000	1500	2000	2500	3000	4000
Max output wattage at low range line input*		1000	1500	1500	1000	1500	N/A	N/A	N/A	N/A
<b>INPUT VOLTAGE SPECIFICATIONS**</b>										
High range VAC input		160-264	160-264	160-264	175-264	175-264	180-264	180-264	160-264	180-264
Low range VAC input		85-159	85-159	85-159	90-132	90-132	N/A	N/A	N/A	N/A
VAC input selection		Wide Range	Wide Range	Wide Range	Manual	Manual	N/A	N/A	N/A	N/A
VAC input phases		Single	Single	Single	Single	Single	Single	Single	Single	Three
<b>OUTPUT MODULE SPECIFICATIONS</b>										
Max # of outputs		9	9	15	9	15	15	21	15	15
# of module slots		3	3	5	3	5	5	7	5	5
<b>MECHANICAL SPECIFICATIONS</b>										
Chassis size	H x W x L, inches	5 x 5.5 x 12.5	5 x 5.5 x 12.5	5 x 8 x 11	5 x 5.5 x 11	5 x 8 x 11	5 x 8 x 11	5 x 11 x 13	5 x 8 x 12.5	5 x 8 x 15
Chassis size	H x W, millimeters	127 x 140	127 x 140	127 x 203	127 x 140	127 x 203	127 x 203	127 x 280	127 x 203	127 x 203
Chassis size	x L, millimeters	x 318	x 318	x 280	x 280	x 280	x 280	x 330	x 318	x 381
<b>INPUT TRANSIENT PROTECTION SPECIFICATIONS</b>										
ESD Immunity EN61000-4-2,		Level 4 15kV/8kV	Level 4 15kV/8kV	Level 4 15kV/8kV	Level 4 15kV/8kV	Level 4 15kV/8kV	Level 4 15kV/8kV	Level 4 15kV/8kV	Level 4 15kV/8kV	Level 4 15kV/8kV
RF Susceptibility EN61000-4-3		Level 3 10V/m	Level 3 10V/m	Level 3 10V/m	Level 3 10V/m	Level 3 10V/m	Level 3 10V/m	Level 3 10V/m	Level 3 10V/m	Level 3 10V/m
Fast Transient/Burst EN61000-4-4		Level 3 ±2kV	Level 3 ±2kV	Level 3 ±2kV	Level 3 ±2kV	Level 3 ±2kV	Level 3 ±2kV	Level 3 ±2kV	Level 3 ±2kV	Level 3 ±2kV
Surge Immunity EN61000-4-5 (Line-Line)		Class 4 2kV	Class 4 2kV	Class 4 2kV	Class 4 2kV	Class 4 2kV	Class 4 2kV	Class 4 2kV	Class 4 2kV	Class 4 2kV
Surge Immunity EN61000-4-5 (line-Gnd)		Class 4 4kV	Class 4 4kV	Class 4 4kV	Class 4 4kV	Class 4 4kV	Class 4 4kV	Class 4 4kV	Class 4 4kV	Class 4 4kV

\*Maximum wattage above 100VAC input for SPF/HPF

From 1000 to 4000 Watts

Models with active Power Factor Correction (PFC) are EN61000-3-2 compliant

**SPM3/SMM3**  
**1000 WATTS**

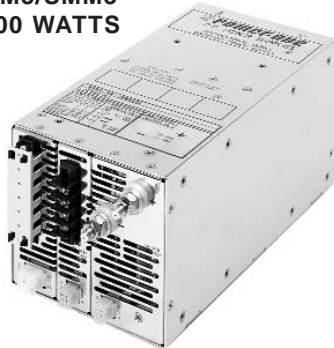

**SPF3/SMF3**  
**1350 WATTS**  
**.99 PFC**

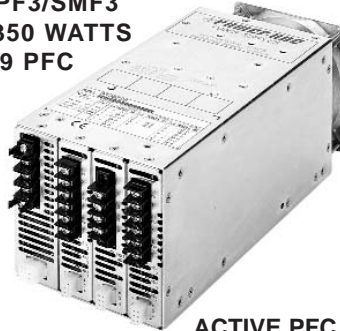

**ACTIVE PFC**

**SPM5/SMM5**  
**1500 WATTS**

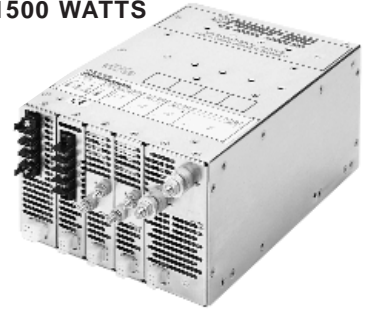

**HPF3/HMF3**  
**2000 WATTS**  
**.99 PFC**

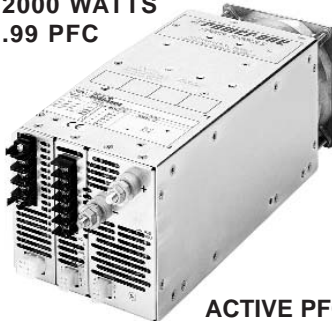

**ACTIVE PFC**

**HPM5/HMM5**  
**2000 WATTS**

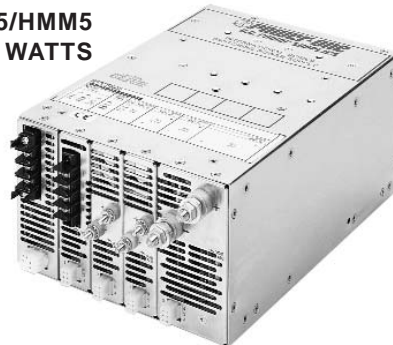

**HPF5/HMF5**  
**2000 WATTS**  
**.99 PFC**

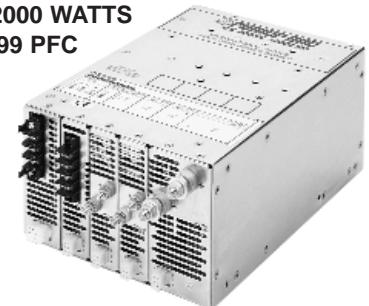

**ACTIVE PFC**

**HPM7/HMM7**  
**2500 WATTS**

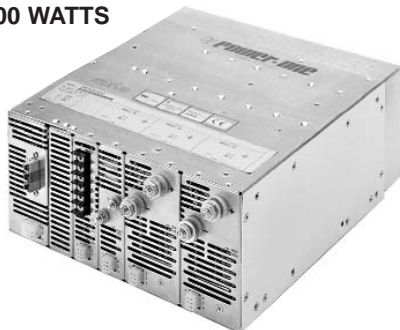

**RPF5/RMF5**  
**3000 WATTS**

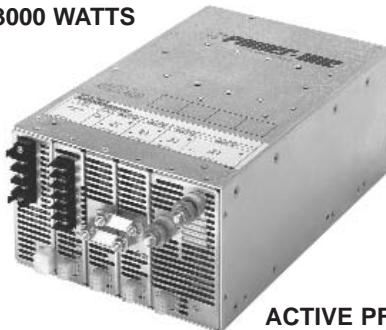

**ACTIVE PFC**

**RPM5/RMM5**  
**4000 WATTS**  
**3 PHASE**  
**INPUT**

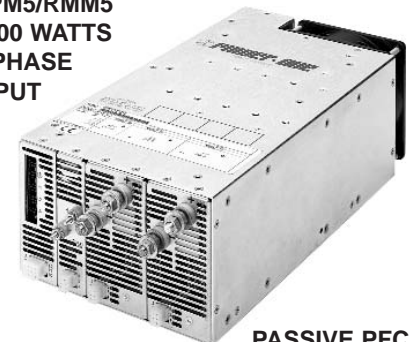

**PASSIVE PFC**

**MODULAR SYSTEM OVERVIEW AND SELECTION**

**Modular System Overview**

Power-One's Modular High Power Series products are configured with separate switch-mode DC output modules to provide the voltage and current ratings required by each specific application.

The system is based on a 300 VDC system power bus derived from either the AC utility line, or a user-supplied 300 VDC source. This 300 VDC bus provides the bulk DC required by each output module for conversion to its specified output voltage and current ratings.

As shown in the block diagram, this independent modular approach provides complete isolation between the outputs, as well as all other system elements. Also, the switching circuitry of each output module is clocked and synchronized by the sync & bias supply section to reduce electrical interference between the outputs.

**Selection**

The modularity of these high power products allows the user to specify a power system configured from a wide selection of standard off-the-shelf, plug-in modules. The power system is delivered completely assembled, burned in, and tested. A part number comprised of a series designation, module listing, and options can be configured as follows:

1. Choose a chassis based on required wattage, number of outputs, and power factor.
2. Select modules following the guidelines in the configuration section.
3. Decide on the options. Standard options are listed in the configuration section. Please call the factory for special requirements, such as logic option cards.

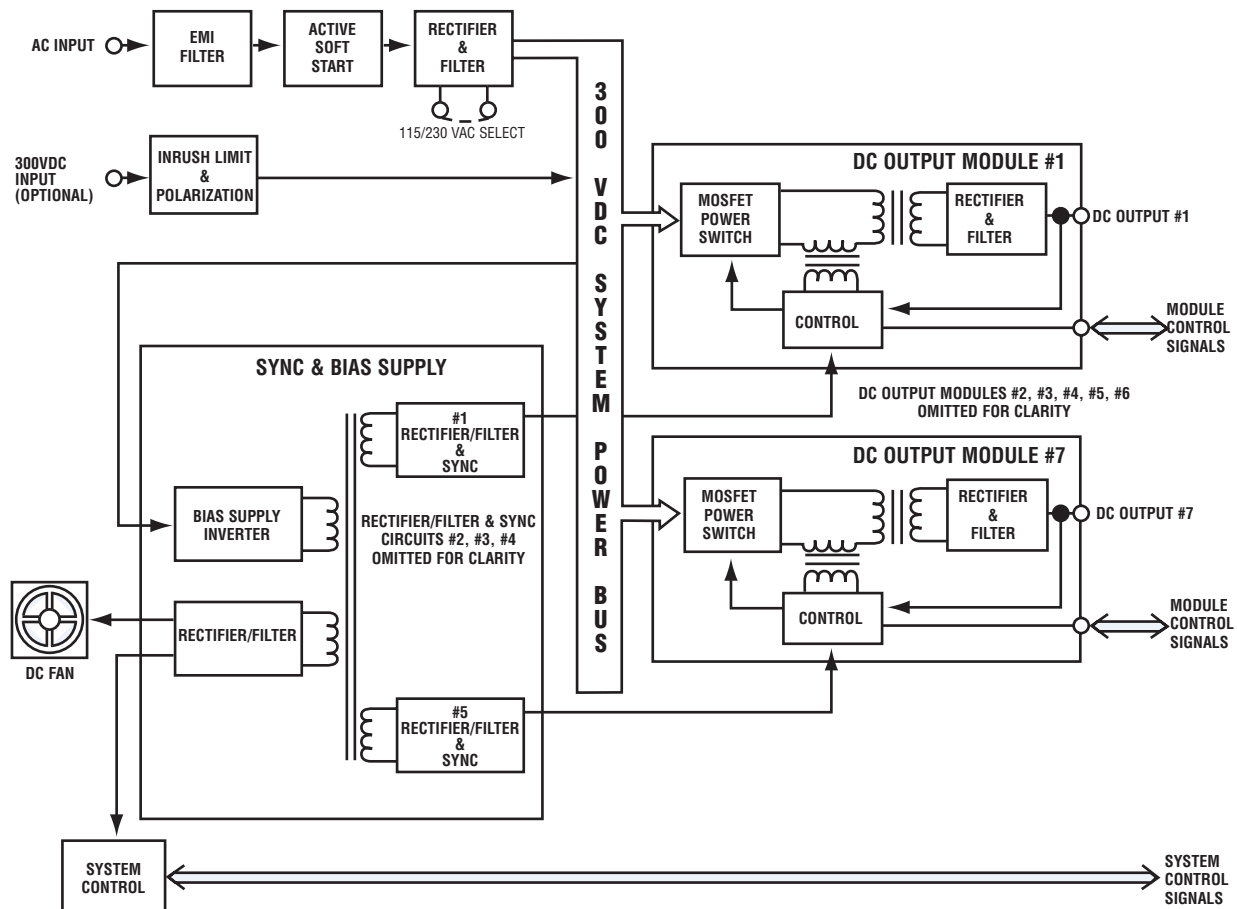

## CONFIGURATION NOTES AND OPTIONS

### Configuration Notes

- Modules are designated left to right in the part number but are installed right to left in the chassis.
- Single and double wide modules occupy one and two chassis slots, respectively. Confirm that the total number of slots required does not exceed the chassis slot capacity.
- Not all modules can be used in all slots. Refer to the compatibility table below.
- Fill blank slots with K or L option.

**EXAMPLE:** OUTPUTS SELECTED    5V @ 150A  
     12V @ 20A  
     -12V @ 20A

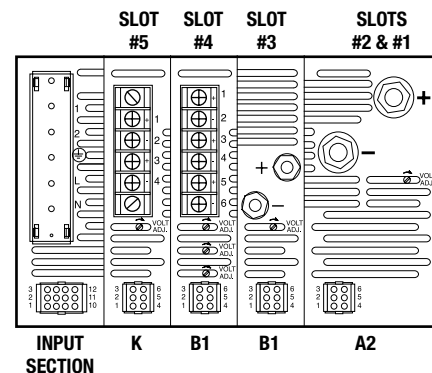
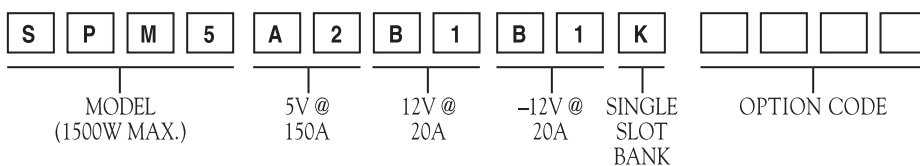

All chassis slots are numbered in right-to-left sequence

### Standard Options

SYSTEM INHIBIT (OPT A, B & C)			INPUT POWER FAIL WARNING (OPT M, N & P)		OTHER OPTIONS
POWER OUTPUT			OPTION	SIGNAL OUTPUT	DESCRIPTION
Std	Logic Low	Open Ckt. or Logic High	Std	+5V  Hi To Lo Transition	K – Single-Width Slot Blank L – Double-Width Slot Blank  See Paralleled Module Configurations on Page 8 for Additional Options
A	Logic High	Open Ckt. or Logic Low	N	 Open Collector Conducts To Give Signal	
B	Open Ckt. or Logic High	Logic Low	M	+5V  Lo To Hi Transition	
C	Open Ckt. or Logic Low	Logic High	P	 Open Collector Opens To Give Signal	

### Module and Chassis Compatibility

Confirm that the number listed in the compatibility column of the module selector guide is equal to or less than the lowest number specified for the module slots pictured below. Example: The SPF3 can only use modules with a

slot compatibility of 1 in the slot closest to the input section, but can use any module with a compatibility number of four or less in the other two slots. Bold lines designate adjoining slots that can be used for double wide modules.

#### SPF3/SMF3/HPF3/HMF3

INPUT	1	≤4	≤4
-------	---	----	----

#### HPF5/HMF5/RPF5/RMF5

INPUT	1	≤4	≤3	≤4	≤4
-------	---	----	----	----	----

#### RPM5/RMM5

INPUT	≤5	≤5	≤5	≤5	≤5
-------	----	----	----	----	----

#### SPM3/SMM3

INPUT	1	≤2	≤2
-------	---	----	----

#### SPM5/SMM5/HPM5/HMM5

INPUT	1	≤4	≤3	≤4	≤4
-------	---	----	----	----	----

#### HPM7/HMM7

INPUT	1	≤4	≤4	≤4	≤4	≤4	≤4
-------	---	----	----	----	----	----	----

## MODULE SELECTOR GUIDE

### SINGLE VOLTAGE OUTPUT MODULES (For Preset Voltage Information, Consult Factory)

NOMINAL VOLTAGE	ADJUSTMENT RANGE	CURRENT (AMPS) @ 50°C (NOTE A)	MODULE	SLOTS USED	SLOT COMPATIBILITY	NOISE & RIPPLE (mV PK-PK) TYPICAL/MAX (NOTE B)	OUTPUT CONNECTION
1.5V	1.5 - 1.8V	35	<b>T1</b>	1	1	30/50	Type II
1.5V	1.5 - 1.8V	60	<b>T6</b>	1	1	30/50	Type I
1.5V	1.5 - 1.8V	250	<b>T4</b>	2	2	30/50	Type III
2V	1.8 - 2.2V	80	<b>F8</b>	1	3	25/40	Type I
2V	2 - 2.2V	35	<b>F1</b>	1	1	20/50	Type II
2V	2 - 2.2V	60	<b>AG (Note C)</b>	1	1	30/50	Type I
2V	2 - 2.2V	60	<b>F6</b>	1	1	30/50	Type I
2V	2 - 2.2V	150	<b>F2</b>	2	2	30/50	Type III
2V	2 - 2.2V	180	<b>CS</b>	2	5	30/50	Type III
2V	2 - 2.2V	250	<b>F4</b>	2	2	30/50	Type III
2V	2 - 2.2V	320	<b>F7</b>	2	5	30/100	Type III
2.3V	2.07 - 2.53	35	<b>BJ</b>	1	1	30/50	Type II
3.3V	2.97 - 3.63	35	<b>H1</b>	1	1	30/50	Type II
3.3V	2.97 - 3.63	60	<b>H6</b>	1	1	30/50	Type I
3.3V	2.97 - 3.63	80	<b>H8</b>	1	3	40/50	Type I
3.3V	2.97 - 3.63	90	<b>DA</b>	1	5	30/50	Type I
3.3V	2.97 - 3.63	150	<b>H2</b>	2	2	30/40	Type III
3.3V	2.97 - 3.63	250	<b>H4</b>	2	2	30/50	Type III
3.3V	2.97 - 3.63	320	<b>H7</b>	2	5	50/100	Type III
5V	4.5 - 5.5	35	<b>A1</b>	1	1	35/50	Type II
5V	4.5 - 5.5	60	<b>A6</b>	1	1	15/50	Type I
5V	4.5 - 5.5	80	<b>A8</b>	1	3	15/50	Type I
5V	4.5 - 5.5	90	<b>DT</b>	1	5	15/50	Type I
5V	4.5 - 5.5	150	<b>A2</b>	2	2	30/50	Type III
5V	4.5 - 5.5	220/250	<b>A4 (Note D)</b>	2	3/4	30/50	Type III
5V	4.5 - 5.5	320	<b>A7</b>	2	5	30/100	Type III
5V	4.5 - 5.5	375	<b>QA</b>	2	5	30/50	Type III
6V	5.4 - 6.6	35	<b>AU</b>	1	1	65/90	Type II
6V	5.4 - 6.6	80	<b>FD</b>	1	3	30/60	Type I
6V	5.4 - 6.6	100	<b>CT</b>	1	5	40/60	Type I
6V	5.4 - 6.6	120	<b>BY</b>	2	2	40/60	Type III
6V	5.4 - 6.6	250	<b>CU</b>	2	5	40/100	Type III
8V	7.2 - 8.8	65	<b>AJ</b>	2	2	53/80	Type III
8V	7.2 - 8.8	160	<b>FA</b>	2	5	40/200	Type III
8V	7.2 - 8.8	50	<b>GM</b>	1	4	40/60	Type I
8.5V	7.65 - 9.35	20	<b>CF</b>	1	1	50/75	Type II
10V	9 - 11	20	<b>AW</b>	1	1	66/100	Type II
10V	9 - 11	40	<b>BE</b>	1	3	40/60	Type I
10V	9 - 11	50	<b>CV</b>	1	5	66/100	Type I
10V	9 - 11	65	<b>AQ</b>	2	2	66/100	Type III
10V	9 - 11	160	<b>CW</b>	2	5	100/200	Type III
12V	10.8 - 13.2	20	<b>B1</b>	1	1	80/120	Type II
12V	10.8 - 13.2	40	<b>B6</b>	1	3	40/60	Type I
12V	10.8 - 13.2	50	<b>B8</b>	1	4	40/60	Type I
12V	10.8 - 13.2	65	<b>B2</b>	2	2	80/120	Type III
12V	10.8 - 13.2	80	<b>BC</b>	2	3	80/120	Type III
12V	10.8 - 13.2	135	<b>DE</b>	2	5	120/240	Type III
15V	13.5 - 16.5	16	<b>AF (Note E)</b>	1	1	15/35	Type II
15V	13.5 - 16.5	16	<b>C1</b>	1	1	100/150	Type II
15V	13.5 - 16.5	33	<b>C6</b>	1	3	30/60	Type I
15V	13.5 - 16.5	50	<b>C5</b>	1	5	100/150	Type I
15V	13.5 - 16.5	52	<b>C2</b>	2	2	100/150	Type III
18V	16.2 - 19.8	44	<b>GD</b>	1	4	80/120	Type I
24V	21.6 - 26.4	10	<b>D1</b>	1	1	160/240	Type II
24V	21.6 - 26.4	15	<b>D6</b>	1	2	80/120	Type II
24V	21.6 - 26.4	29	<b>D8</b>	1	4	70/110	Type I
24V	21.6 - 26.4	32	<b>D2</b>	2	2	160/240	Type III
24V	21.6 - 26.4	33	<b>D5</b>	1	5	60/100	Type I
24V	21.6 - 26.4	42	<b>GH</b>	1	5	50/100	Type I
28V	25.2 - 30.8	8.6	<b>E1</b>	1	1	200/280	Type II
28V	25.2 - 30.8	16	<b>E7 (Note F)</b>	1	1	50/100	Type I
28V	25.2 - 30.8	26	<b>E8</b>	1	4	70/100	Type I

Modules that are highlighted in yellow or shaded are not recommended for new designs.

## MODULE SELECTOR GUIDE

### SINGLE VOLTAGE OUTPUT MODULES (Continued)

NOMINAL VOLTAGE	ADJUSTMENT RANGE	CURRENT (AMPS) @ 50°C (NOTE A)	MODULE	SLOTS USED	SLOT COMPATIBILITY	NOISE & RIPPLE (mV PK-PK) TYPICAL/MAX (NOTE B)	OUTPUT CONNECTION
28V	25.2 - 30.8	27	<b>E2</b>	2	2	150/280	Type III
28V	25.2 - 30.8	29	<b>E5</b>	1	5	70/100	Type I
30V	27 - 33	8	<b>EG</b>	1	1	30/40	Type II
36V	32.4 - 39.6	20	<b>J8</b>	1	4	100/200	Type I
36V	32.4 - 39.6	21	<b>J2</b>	2	2	100/200	Type III
36V	32.4 - 39.6	23	<b>J5</b>	1	5	100/200	Type I
48V	43.2 - 52.8	5	<b>G1</b>	1	1	400/480	Type II
48V	43.2 - 52.8	12.5	<b>G4</b> (Note E)	1	3	40/60	Type I
48V	43.2 - 52.8	16	<b>G2</b>	2	2	135/200	Type III
48V	43.2 - 52.8	16	<b>G8</b>	1	4	60/100	Type I
48V	43.2 - 52.8	19	<b>G6</b>	1	5	60/100	Type I

### WIDE-RANGE SINGLE OUTPUT, VARIABLE VOLTAGE MODULES

NOMINAL VOLTAGE	ADJUSTMENT RANGE	CURRENT (AMPS) @ 50°C (NOTE A)	MODULE	SLOTS USED	SLOT COMPATIBILITY	NOISE & RIPPLE (mV PK-PK) TYPICAL/MAX (NOTE B)	OUTPUT CONNECTION
1.0V	0.7 - 2.1V	320	<b>ER</b>	2	5	30/100	Type III
2.0V	1.5 - 2.8V	375	<b>QF</b> (Note C)	2	5	50/50	Type III
1.9V to 3V	1.9V to 3V	150	<b>AB</b>	2	2	50/50	Type III
3.3V	2.5V to 4V	375	<b>QH</b>	2	5	30/75	Type III
14V to 24V	14V to 24V	10	<b>W1</b>	1	1	80/120	Type II
14V to 24V	14V to 24V	32	<b>BS</b>	2	2	135/200	Type III

### DUAL VOLTAGE OUTPUT MODULES

NOMINAL VOLTAGE	CURRENT (AMPS) @ 50°C (NOTE A)	MODULE	SLOTS USED	SLOT COMPATIBILITY	NOISE & RIPPLE (mV PK-PK) TYPICAL/MAX (NOTE B)	OUTPUT CONNECTION
12/12	10/4	<b>M4</b> (Note G)	1	1	120/240	Type II
±12	10/10	<b>B4</b> (Note H)	1	1	120/240	Type II
±15	8/8	<b>C4</b> (Note H)	1	1	150/300	Type II
±20	5/5	<b>BQ</b> (Note H)	1	1	80/100	Type II
±24	5/5	<b>D4</b> (Note H)	1	1	80/120	Type II

### TRIPLE OUTPUT VOLTAGE MODULES (Note G)

NOMINAL VOLTAGE	CURRENT (AMPS) @ 50°C (NOTE A)	MODULE	SLOTS USED	SLOT COMPATIBILITY	NOISE & RIPPLE (mV PK-PK) MAXIMUM (NOTE B)	OUTPUT CONNECTION
5/1.5/3.3	15/10/10	<b>FC</b>	1	1	100/100/100	Type II
5/1.5/12	10/10/10	<b>CA</b>	1	1	100/100/120	Type II
5/2.2/12	10/10/10	<b>W6</b>	1	1	100/100/120	Type II
5/12/12	10/10/10	<b>M6</b>	1	1	50/120/120	Type II
5.2/12/12	15/8/8	<b>BA</b>	1	1	100/180/180	Type II
5.2/12/12	5/16/7	<b>AE</b>	1	1	60/160/120	Type II
5/12/24	10/10/5	<b>U6</b>	1	1	50/120/240	Type II
5/15/15	10/8/8	<b>V6</b>	1	1	50/150/150	Type II
5/24/24	10/5/5	<b>R6</b>	1	1	50/240/240	Type II
12/12/12	10/10/10	<b>N6</b>	1	1	120/120/120	Type II
5/15/12	10/8/10	<b>EC</b>	1	1	50/150/120	Type II
24/12/12	5/10/10	<b>P6</b>	1	1	240/120/120	Type II

- NOTES:**
- A) For ambient temperatures above 50 °C, output current must be linearly derated to 50% at the maximum operational ambient temperature, 70 °C.
  - B) The output noise and ripple measurement is bandwidth limited to 20 MHz.
  - C) Module is designed to accommodate output cable losses of up to one volt.
  - D) A4 module provides 220A in chassis with slot compatibility rating of 3, and 250A in chassis with slot compatibility rating of 4.
  - E) Module is designed for use in applications demanding low noise and ripple. Consult factory for further specifications.
  - F) Not to be used with SPM2 and SPM3 chassis.
  - G) All triple output modules, as well as the M4 dual-output module, have floating outputs. Like voltages may be shared within the same module. All triple output adjustments and interface signals are for output #1. Consult factory for more information.
  - H) The dedicated negative (-) output is quasi-regulated. Both outputs require a small minimum load to perform to specification. Consult factory for more information.

Modules that are highlighted in yellow or shaded are not recommended for new designs.

## PARALLELED MODULE CONFIGURATIONS

Single output, similar-voltage output modules can be configured for parallel operation to provide output currents up to 840 amps. Factory standard paralleling suffixes are shown below. All paralleling suffixes include factory-installed bus bars and internally-connected current sharing. Please consult factory for paralleling configurations not shown.

- Choose appropriate chassis and modules as described in the Selection and Configuration Notes sections.
- Select the required output connection type as shown in the Module Selector Guide.
- Select the paralleling suffix that corresponds to the selected output modules. (The paralleling suffix follows after all other option codes.)

CHASSIS	CHASSIS SLOT							PARALLELING SUFFIX
	7	6	5	4	3	2	1	
<b>3 SLOT CHASSIS:</b>								
SPM3, SMM3						I	I	YA
SPF3, SMF3					I	I	I	YB
HPF3, HMF3					II	I	I	YC
					I	III		YD
					II	III		YE
<b>5 SLOT CHASSIS:</b>								
SPM5, SMM5						I	I	YF
HPM5, HMM5						I	I	YG
HPF5, HMF5				I	N/U	I	I	YJ
RPM5, RMM5				I	I	I	I	YJ
RPF5, RMF5			II	I	I	I	I	YM
			I	I	I	I	I	YN
					I	III		YP
					III	III		YH
			II	III	III			YR
			I	III	III			YS
<b>7 SLOT CHASSIS:</b>								
HPM7, HMM7						I	I	YF
						I	I	YG
				I	N/U	I	I	YJ
				I	I	I	I	YJ
			I	I	I	I	I	YN
					I	III		YP
					III	III		YH
			I	III	III			YS
			III	III	III			YT

**EXAMPLE:** REQUIREMENT: 5V @ 300A

- Select Chassis: HPF3
- Select Modules: A4 (5V @ 250A), A6 (5V @ 60A)
- Choose Corresponding Paralleling Suffix: YD
- Final Part Number: HPF3A4A6YD

### LIMITATIONS FOR STANDARD PARALLELING SYSTEM

- Single output modules only
- Ripple and noise limit will be 20% over the largest value paralleled
- For paralleling modules over 320A, consult factory

### OUTPUT CONNECTIONS

Type I = #10-32 studs  
Type II = Barrier Block  
Type III = 5/16"-18 studs

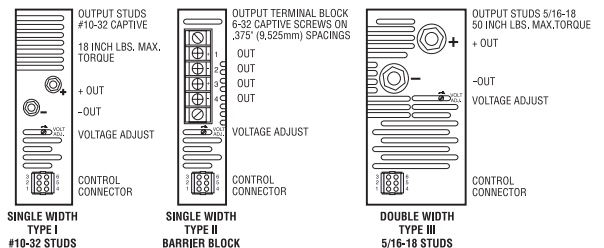



**DC OUTPUT MODULE SPECIFICATIONS**

**SINGLE AND DUAL OUTPUT MODULES**

PARAMETER	CONDITIONS/DESCRIPTION	MIN	NOM	MAX	UNITS
Output Voltage Adjustment Range	(V2 output is not adjustable)	-10		+10	%
Output Current	At 0°C to 50°C ambient.	See Module Selector Guide.			
Ambient Temperature Range	100% rated load. Derated linearly to 50% load.	0 0		50 70	°C
Initial Voltage Setting	Factory set V1 output	-1		+1	%
Output Voltage Adjustment	V1 output	-10		+10	%
Margining/Remote Voltage Adjustment	Range (provided for V1 output only). Programming sensitivity from 2.0V (provided for V1 output only).	-10 -4	-5	+10 -6	% %/V
Remote Voltage Sense	Total cable drop (provided for V1 output only).			0.5	V
Temperature Coefficient	At 0°C to 50°C ambient.		0.01	0.02	%/°C
Long-term Voltage Drift	1000 hours.			0.1%	
Line Regulation	Over input operating range.		0.05	0.1	%
Load Regulation Single Output Modules	5 Volt Modules 0% to 100% load with remote sense.			< 10	mV
	0% to 100% load without remote sense.			< 60	mV
Consult Factory For Specific Ratings	> 5 Volt Modules 0% to 100% load with remote sense.			< 30	mV
	0% to 100% load without remote sense.			< 75	mV
Cross Regulation Between Single Output Modules in One Chassis	0% to 100% load change.			0	%
Load Regulation, Dual Output Modules	Positive Output 0% to 100% load with remote sense.			< 30	mV
	0% to 100% load without remote sense.			< 75	mV
Load Regulation, Dual Output Modules	Negative Output 0% to 100% load.			5	%
Cross Regulation, Dual Output Modules	Positive Output 0% to 100% load change.			0.1	mV
Cross Regulation, Dual Output Modules	Negative Output 10% to 100% load change.			5	%
Minimum Load Current	Dual output modules only. See factory data sheets.	1			Amp
Current Limit	Factory set. As a % of full rated I <sub>o</sub> . Dual output modules use primary power limiting. See module ratings.	110%	115%	120%	Amp
Short Circuit Current	As a % of full rated I <sub>o</sub> .		100%		Amp
Current Sharing	Current sharing accuracy as a % of full rated I <sub>o</sub> . (V1 output)			1	%
Overvoltage Protection (V1 output)	Trip point as a % of V <sub>o</sub> for V <sub>o</sub> equal to or greater than 5V. Resettable by recycling input.	115%	120%	125%	V
Reverse Polarity Protection	Reverse current as a % of full rated I <sub>o</sub> . Reverse voltage externally applied.			100%	Amp
Inhibit	Logic LO = off Sink current.			0.9 0.4	V mA
	Logic HI = on Source current.	2		20	V µA
Output Good Signal (V1 output)	Logic LO (when V <sub>o</sub> deviates ±3% to ±5% from adjusted set point). Sink current.			0.9 40	V mA
	Logic HI (with internal pull-up to 5V).		1.5		kΩ
Noise and Ripple	20 MHz bandwidth.	See module ratings.			mV <sub>PP</sub>
Transient Response	For V <sub>o</sub> equal to or greater than 5V, 75% to 100% load step. 50% to 100% load step. Recovering to 1% within 400 µSec, Slew rate = 1A/µSec.			2% 4%	mV <sub>PK</sub>
Turn-On Delay	After input applied.			1	Sec
	After inhibit released.			50	ms
Rise Time	5% to 95% of V <sub>o</sub> .			50	ms
Overshoot	Overshoot as a % of V <sub>o</sub> at turn-on.			0%	V
Turn-Off Delay	After inhibit or OVP trip.			500	µs

Specifications in this section are general and may vary according to specific modules.

**DC OUTPUT MODULE SPECIFICATIONS**

**TRIPLE OUTPUT MODULES**

PARAMETER	CONDITIONS/DESCRIPTION	OUTPUT #1			OUTPUT #2			OUTPUT #3			UNITS
		MIN.	NOM.	MAX	MIN.	NOM.	MAX	MIN.	NOM.	MAX	
Output Current	At 0°C to 50°C ambient.	See module ratings.									
Ambient Temperature Range	100% rated load. Derated linearly to 50% load.	0		50	0		50	0		50	°C
Initial Voltage Setting	Initial voltage set point as a % of Vo.	-1%		+1%	-1%		+1%	-1%		+1%	V
Output Voltage Adjustment Range		-10%		+10%	-10%		+10%	-10%		+10%	V
Margining/Remote Voltage Adjustment	Range. Programming sensitivity, from 2.5V.	-10%		+10%							V %/V
Remote Voltage Sense	Total cable drop.			0.5							V
Temperature Coefficient	At 0°C to 50°C ambient.		0.01	0.02		0.01	0.02		0.01	0.02	%/°C
Long Term Voltage Drift	1000 hours.			0.1%			0.1%			0.1%	
Line Regulation	Over input operating range.		0.05	0.1		0.05	0.1		0.05	0.1	%
Load Regulation	0% to 100% load w/remote sense 0% to 100% load w/o remote sense (Note 1)		0.1	0.2							% mV/Amp
Cross Regulation	0% to 100% load change.			0			0			0	%
Minimum Load Current				0			0			0	Amp
Current Limit	Factory set. As a % of full rated Io.	105%		120%	105%		120%	105%		120%	Amp
Short Circuit Current	As a % of full rated Io.			100%			100%			100%	Amp
Current Sharing (Note 2)	Current sharing accuracy as a % of full rated Io. Factory calibrated at 100% load.			5			5			5	%
Reverse Voltage Protection	Reverse current as a % of full rated Io. Reverse voltage externally applied.			100%			100%			100%	Amp
Inhibit	Logic LO = off Sink current.			0.4							V mA
	Logic HI = on Source current.	2.5		20							V µA
Output Fault Signal	Logic LO upon current limit detection, OVP, or shut down. Logic LO (with 3 mA sink).			0.7			0.7			0.7	V
	Logic HI (internal pull-up to 5V)		1.5			1.5			1.5		kΩ
Turn-On Delay	After input applied. After inhibit released.			1			1			1	Sec ms
Rise Time	5% to 95% of Vo.			50			50			50	ms
Overshoot	Overshoot as a % of Vo.			3%			3%			3%	V
Turn-Off Delay	After inhibit or OVP trip.			500			500			500	µs
Overvoltage Protection	Provided on output #1 only. Trip point as a % of Vo.	5V Output: 130%, ±5% of Vo. 12V Output: 120%, ±5% of Vo. 24V Output: 115%, ±5% of Vo.									
Resettable by recycling input.											
Noise and Ripple	20 MHz bandwidth.	Output Voltage Vo									
		5V	12V	15V	24V						
	NOM.	65	80	100	160						
	MAX.	100	120	150	240						
200 MHz bandwidth.	Output Voltage Vo										
	5V	12V	15V	24V							
NOM.	20	20	25	40							
MAX.	30	30	38	60							
Transient Response	75% to 100% load change @ 0.4A/µs.	Output Voltage Vo									
	50% to 100% load change @ 0.4A/µs. Recovery to 1% within 400 µs.	5V	12V	15V	24V						
		150	240	240	480						
		300	480	480	960						

**NOTES:** 1) 20 mV max below 5% load.

2) Identical voltages can be paralleled at the factory. Please consult the factory.

## CHASSIS SPECIFICATIONS:

SPF3 / SMF3\* HPF3 / HMF3\* HPF5 / HMF5\* RPF5 / RMF5\*

### INPUT

PARAMETER	CONDITIONS	MIN.	NOM.	MAX.	UNITS
Input Voltage	AC Input	85		264	VAC
Input Current	$\eta=70\%$ 115 VAC; 1000W 115 VAC; 1300W 115 VAC; 1500W 230 VAC; 1350W 230 VAC; 1500W 230 VAC; 2000W 230 VAC; 3000W			12.8 16.2 19.2 8.6 9.6 12.8 19.0	ARMS
Power Factor	85 - 264 VAC; >500W (SPF3, HPF3, HPF5) 180 - 264 VAC; >750W (RPF5)	0.98 0.98			W/VA
Inrush Surge Current	Vin = 132VAC (one cycle) Vin = 264VAC (one cycle)			20 40	APK
Input Frequency	AC Input	47		63	Hz
Start Up Time	From time AC is applied to Vout is in regulation			1.5	Sec
Hold-up Time	85 - 264 VAC at rated maximum power	23			ms
Input Power Fail Warning	Logic signal time before regulation dropout due to loss of input power	5			ms
Overtemperature Warning	Advance warning before shutdown	10			ms

### SAFETY AND EMI

Agency Approvals	UL1950 CSA 22.2 No. 950 EN60950 (TÜV)				
Line Harmonic Disturbance	EN60555-2 EN61000-3-2				
Dielectric Withstand Voltage	Input to Output ("Y" capacitors disconnected) Input to Chassis Output to Chassis	4300 2300 500			VDC
Leakage Current	Per UL1950 and CSA 22.2 No. 950 Per EN60950			1.5 2.5	mA
Electromagnetic Interference	FCC CFR title 47 Part 15, Sub-Part B Conducted EN55022 / CISPR 22, Conducted			Level A	

### GENERAL

Output Power	SPF3 Full Load, 85-100 VAC input SPF3 Full Load, 101-159 VAC input SPF3 Full Load, 160-264 VAC input HPF3/HPF5 Full Load, 85-100 VAC input HPF3/HPF5 Full Load, 101-159 VAC input HPF3/HPF5 Full Load, 160-264 VAC input RPF5 Full Load, 160-264 VAC input			875 1000 1350 1300 1500 2000 3000	Watts
Efficiency	Full Load, Nominal Line Input		75		%
Vibration	Random Vibration, 10 Hz to 2 kHz, 3 axis			6	GRMS
Shock	Operating, peak acceleration			20	GPK
Operating Temperature	At 100% load Derate linearly above 50°C to 50%	0		50 70	°C
Storage Temperature		-40		85	°C
Altitude	Operating Non-Operating			10,000 50,000	Feet
Relative Humidity	Non-Condensing			95	%
Acoustical Noise	"A" Weighted @ 1 meter			50	dB
Cooling	Static pressure through system enclosure			0.05	In of H <sub>2</sub> O

\*Metric mounting chassis meet all specifications of non-metric models.

## CHASSIS SPECIFICATIONS: SPM3 / SMM3\*

### INPUT

PARAMETER	CONDITIONS	MIN.	NOM.	MAX.	UNITS
Input Voltage	AC Input				
	Low range	90	115	132	VAC
	High range	175	230	264	VAC
	DC Input	250	300	350	VDC
Input Current	1000 Watt Load				
	Vin = 90 VAC			25	ARMS
	Vin = 175 VAC			13	ARMS
	Vin = 250 VDC			3	ADC
Inrush Surge Current	SPM3				
	Vin = 132 VAC Vin = 264 VAC			19 38	APK
Input Frequency	With AC Input	47		440	Hz
Hold-up Time	After last AC line peak with 115/230 VAC Input	23			ms
Input Power Fail Warning	Logic signal before regulation dropout due to loss of input power	5			ms
Overtemperature Shutdown	System shutdown due to excessive internal temperature	75		85	°C
Thermal Warning	Advanced warning before overtemperature shutdown	10			ms

### SAFETY AND EMI

Agency Approvals	UL1950 CSA22.2 #950 EN60950 (TÜV)				
Dielectric Withstand Voltage	Input to Output	4300			VDC
	Input to Chassis	2300			
	Output to Chassis	500			
Insulation Resistance	Input to Output	10			MΩ
	Input to Chassis	10			
	Output to Chassis	2			
Leakage Current	SPM3			1.75/1.25	mA
Safety Spacing	Primary to Secondary	8			mm
	Primary to Chassis	4			
Electromagnetic Interference	FCC CFR title 47 Part 15, Sub-Part B Conducted EN55022 / CISPR 22, Conducted			Level A	

### GENERAL

Output Power (Max)	SPM3			1000	Watts
Efficiency	Full load, typical modules.	75			%
Power Factor	115/230 VAC input		0.7		W/VA
Vibration	Random vibration from 10Hz to 2 kHz, (3 axis)			6.0	GRMS
Shock	Operating: peak acceleration			20	GPK
Operating Temp.	At 100% Load	0		50	°C
	Derate to 50% at 70°C			70	
Storage Temp.		-40		85	°C
Altitude	Operating (Consult factory for operation above 10,000 feet)			10,000	Feet
	Non-operating			50,000	Feet
Relative Humidity	Non-condensing			95	%
Acoustical Noise	"A" weighted, anechoic at 1 meter			50	dB
Cooling	Internal Fan Cooled (At Sea Level)		50		CFM

\*Metric mounting chassis meet all specifications of non-metric models.

## CHASSIS SPECIFICATIONS: SPM5 / SMM5\* HPM5 / HMM5\* HPM7 / HMM7\*

### INPUT

PARAMETER	CONDITIONS	MIN.	NOM.	MAX.	UNITS
Input Voltage HPM5/HPM7 Operate Only On High Range	AC Input				
	Low range-SPM5 only	90	115	132	VAC
	High range	175	230	264	VAC
	DC Input				
	DC Input Range	250	300	350	VDC
Input Current	Vin = 90 VAC			2	ARMS/100 Watts Load
	Vin = 175 VAC			1	ARMS/100 Watts Load
	Vin = 250 VDC			0.53	ADC/100 Watts Load
Inrush Surge Current	Vin = 132 VAC			19	APK
	Vin = 264 VAC			38	
Input Frequency	With AC Input	47		440	Hz
Hold-up Time	After last AC line peak with 115/230 VAC Input	30			ms
Input Power Fail Warning	Logic signal before regulation dropout due to loss of input power	3			ms
Thermal Warning	Warning before overtemperature shutdown	10			ms

### SAFETY AND EMI

Agency Approvals	UL1950 CSA22.2 #950 EN60950 (TUV)				
Dielectric Withstand Voltage	Input to Output	4300			VDC
	Input to Chassis	2300			
	Output to Chassis	500			
Insulation Resistance	Input to Output	10			MΩ
	Input to Chassis	10			
	Output to Chassis	10			
Leakage Current	Per UL1950 and CSA 22.2 No. 950 Per EN60950			1.5 2.5	mA
Safety Spacing	Primary to Secondary	8			mm
	Primary to Chassis	4			
Electromagnetic Interference	FCC CFR Title 47 Part 15, Sub-Part B Conducted EN55022 / CISPR 22, Conducted			Level A	

### GENERAL

Output Power (Max) - SPM5/HPM5/HPM7				1500/2000/2500	Watts
Efficiency	Full Load		75		%
Power Factor	115/230 VAC input, typical modules.		0.7		W/VA
Vibration	MIL-STD-810D, Method 514.3, Category I, Proc I			6	GRMS
Shock	MIL-STD-810D, Method 516.3, Proc II, IV, VI			20	GPK
Operating Temp.	At 100% Load	0		50	°C
	Derate to 50% at 70°C			70	
Storage Temp.		-40		85	°C
Altitude	Operating (Consult factory for operation above 10,000 feet)			10,000	Feet
	Non-operating			50,000	Feet
Relative Humidity	Non-condensing			95	%
Acoustical Noise	"A" weighted, anechoic at 1 meter			50	dB
Cooling	Internal Fan	80			CFM

\*Metric mounting chassis meet all specifications of non-metric models.

**CHASSIS SPECIFICATIONS: RPM5 / RMM5\***

**INPUT**

PARAMETER	CONDITIONS	MIN.	NOM.	MAX.	UNITS
Input Voltage**	AC Input Three Phase with Ground Phase-to-Phase	180	230	264	VAC
	DC Input	250	300	350	VDC
Input Current	180 VAC			23	ARMS
	208 VAC			20	
	220 VAC			19	ADc
	250 VDC			23	
Inrush Surge Current	Vin = 264 VAC (one cycle)			38	APK
Input Frequency	With AC Input	47		63	Hz
Hold-up Time	After last AC line peak				ms
	208 VAC	20			
	220 VAC	25			
Input Power Fail Warning	Logic signal before regulation dropout due to loss of input power	5			ms
Overtemperature Shutdown	System shutdown due to excessive internal temperature	70	80		°C
Thermal Warning	Advanced warning before shutdown	10			ms

**SAFETY AND EMI**

Agency Approvals	UL1950 CSA 22.2 No. 950 EN60950 (TUV)				
Dielectric Withstand Voltage	Input to Output	4300			VDC
	Input to Chassis	2300			
	Output to Chassis	300			
Insulation Resistance	Input to Output	10			MΩ
	Input to Chassis	10			
	Output to Chassis	2			
Leakage Current	Per UL1950 and CSA 22.2 No. 950 Per EN60950			1.5 2.5	mA
Electromagnetic Interference with 3-phase input and no external filtering	FCC CFR title 47 Part 15, Sub-Part B Conducted EN55022/CISPR 22, Conducted			Level A	

**GENERAL**

Output Power***	Full Load, 230 VAC			4000	Watts
Efficiency	Full Load, 230 VAC		75		%
Power Factor	> 2000 watts @ 60 Hz, > 3000 watts @ 50 Hz with 3-phase input	0.9			W/VA
Vibration	Random vibration from 10Hz to 2 KHz, (3 axis)			6	GRMS
Shock	Operating, peak acceleration			20	GPK
Operating Temp.	At 100% Load	0		50	°C
	Derate linearly above 50°C to 50%			70	
Storage Temp.		-40		85	°C
Altitude	Operating			10,000	Feet
	Non-operating			50,000	
Relative Humidity	Non-condensing			95	%
Acoustical Noise	"A" weighted at 1 meter			60	dB
Cooling	Static pressure through system closure			0.05	In of H <sub>2</sub> O

\*Metric mounting chassis meet all specifications of non-metric models.

\*\* For single-phase operation, please consult factory.

\*\*\* 2800W, MAX with single-phase, 180 - 264VAC. Consult factory.

## **EXCEPTIONAL AC INPUT TRANSIENT IMMUNITY**

### **Initial Analysis**

Power-One has been working with customers to improve our high power products for over ten years. Because these products are often used in industrial environments, some of our customers were concerned with AC input transient immunity. This prompted us to implement an extensive data collection and analysis project which provided the following information:

- 1) AC input monitoring data taken at end-users (our customers' customers) sites revealed extreme input transients with differential transients beyond the highest levels, and longest durations, of the new ISO1000/EN61000-4-5 specification.
- 2) A review of our failure analysis database revealed primary-side component failures which appeared to be caused by excessive input transients. In addition, some customers reported similar failures with high power products manufactured by companies other than Power-One.
- 3) The AC input monitoring data, mentioned in item #1, was used as a starting point in engineering lab testing and Spice modeling. Both methodologies confirmed the failure modes mentioned in item #2.

### **Other Factors**

Given the very high demonstrated MTBF hours of the DC output modules, failures that were thought to be caused by AC input line transients became a significant percentage of overall customer returns. Therefore, the plan to enhance overall reliability included increasing the robustness of the AC input section.

We found that AC input transient immunity is most critical to equipment that is not powered from a standard 115VAC wall socket, and where line impedances (resistive and inductive) are relatively high, and aid in the absorption of transient line conditions. Experience has also shown that the primary cause of damage is differential voltage events (between the lines), not common mode (between line(s) and ground).

**EXCEPTIONAL AC INPUT TRANSIENT IMMUNITY**

**Improvements**

Enhancing the input board design was accomplished by specifying oversized input components and adding Metal Oxide Varistors (MOV's) to protect against both common and differential-mode transients. Before putting the enhanced input board into production, an extensive qualification program was performed which confirmed that the following standards were exceeded:

<b>Specification</b>	<b>Description</b>	<b>Classification</b>	<b>Volts</b>
EN61000-4-2	ESD Immunity	Level 4	8kV
EN61000-4-3	RF Susceptibility	Level 3	10V/m
EN61000-4-4	Fast Transient/Burst Immunity	Level 3	4kV
EN61000-4-5	Surge Immunity		
	Common-mode	Class 4	4kV
	Differential-mode	Class 4	2kV

It is important to note that these are the most stringent levels of each of these specifications. In the case of the critical differential surge immunity level, Power-One's internal design and test levels for high power products are over twice the maximum specification level shown above.

**Field Data Results**

The field data results were impressive. After a year, and over 10,000 units shipped with enhanced AC input sections, our customers have not returned any products that were diagnosed to have AC input transient related failures. This clearly shows that we have significantly improved the field reliability of our high power products and have set a new standard in the industry for AC input transient immunity.

To complement the robustness of the AC input chassis, the DC output modules have a demonstrated MTBF of over 5 million hours. The next three pages describe how the exceptional MTBF of the DC output modules also contributes to making Power-One's high power products the most reliable in the industry.



## DC OUTPUT MODULES DEMONSTRATED MTBF OF 5 MILLION HOURS

### Overview

This report summarizes the methodology, calculations, and results that were used to document the field reliability of standard high power product modules (non-RPM5), and to predict the reliability of the enhanced performance high density modules for the 4,000 Watt RPM5 Series power supply. Based on this data, the typical output module demonstrated MTBF is five million hours with an ambient temperature of 25 °C.

### Basis for Prediction

At the beginning of 1996, Power-One initiated the design of the 4,000 Watt RPM5. This design project produced one of the highest power density AC/DC power supplies in the industry. To support this program, Power-One started an extensive effort to update field reliability information for existing (non-RPM5) modules. In addition to quantifying the reliability for these modules, this information was also used as the basis for predicting the reliability of the new high density RPM5 module designs.

Power-One created a 33-page proprietary report analyzing the field history (by power supply, by module), utilizing years of data. The customer's end-product used in this report operated 24 hours per day, 7 days per week, and accumulated over 140 million unit-hours of field data for this analysis. In addition, three years of field failure data were gathered from Power-One's on-line failure analysis database. Power-One believes this actual demonstrated field history is more valuable and provides a more realistic reliability estimation than that represented by the theoretical calculated predictions of MIL-HDBK-217 or Bellcore TR-332.

### Methodology

The minimum and maximum MTBF (80% confidence level) was established by applying the Chi-Squared method to the collected data. To improve the usefulness of the results in the original report, this report includes similar modules (same/similar PCB and mechanical structure). In the case of the RPM5 Series modules, the respective base module data was used as a starting point and was then modified to reflect new stress levels, new components, modified cooling, etc.

### Results

The data on the following pages present the resulting field reliability of 48 modules. This data includes minimum and maximum FITs (Failures In Time -  $10^9$  hours) and MTBF at 25 °C for each of the modules.

**Vibration testing** is performed in three orthogonal axis from 10 to 2000 Hz, at 6.15 GRMS as part of STRIFE testing.

**Thermal shock testing** includes a 15 °C per minute ramp rate from -30 °C to +80 °C while input power is cycled and outputs are driven to full-rated load. This is also a part of STRIFE testing.



**DC OUTPUT MODULES DEMONSTRATED MTBF OF 5 MILLION HOURS**

**Details of MTBF Information**

Please refer to the table on the following page for MTBF data for specific modules.



Field data included:

- 3 year shipment history
- 19 unique power supply configurations
- 21 types of output modules
- 4 million to 71 million operating hours for individual modules

Data adjustments were objectively made to:

- Eliminate customer induced and other similar failures
- Provide for confidence factors (80%)
- Eliminate non-operating time prior to installation
- Group similar modules with similar failure rates to improve accuracy of data
- Make minor extrapolations for modules that had minor technical variations from subject modules

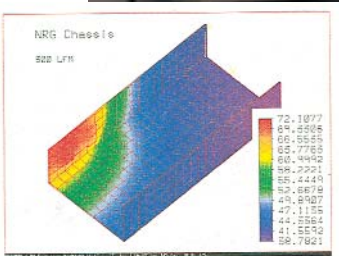

**Computer Aided Design (CAD)** provides thermal modeling, vibration analysis, and circuit simulation data before a prototype is built. Extensive use of computer-based modeling programs contributes to reliability.

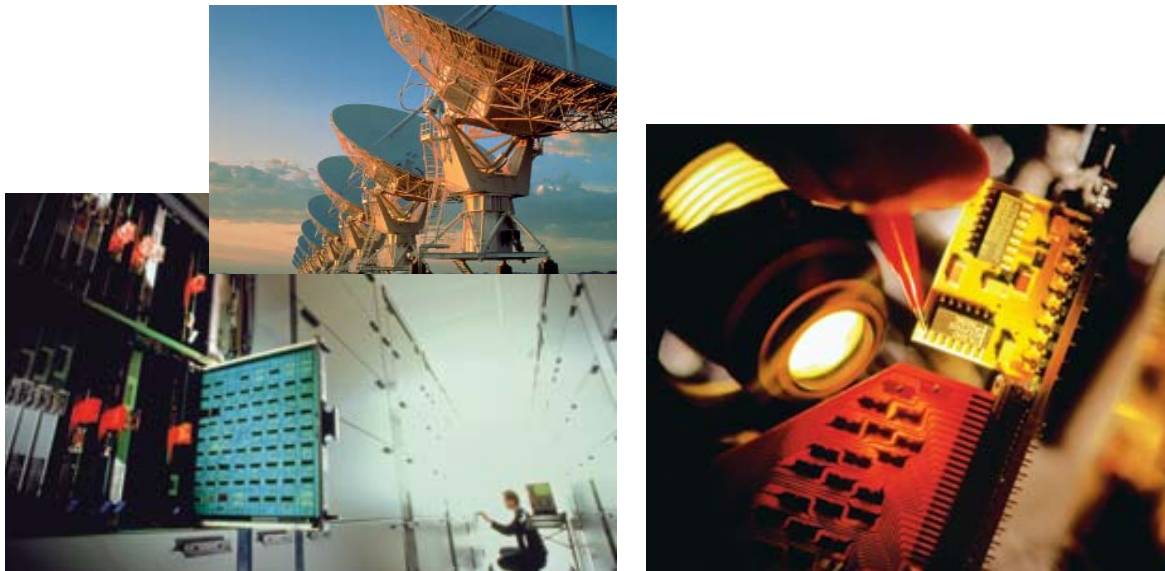

Power-One's modular products have been proven in high-reliability communications and semiconductor test equipment applications.

## High Power DC Output Module Reliability

Based Upon 140,000,000 Unit-Hours of Field Data

MODULE	WIDTH	TYPE	FITS (Failures/10 <sup>6</sup> Hours)		MTBF (millions of Hours)	
			25°C AMBIENT		25°C AMBIENT	
			MINIMUM	MAXIMUM	MINIMUM	MAXIMUM
A1	Single	Standard	117	254	3.94	8.55
A2	Double	Standard	139	205	4.88	7.19
A4	Double	Standard	139	205	4.88	7.19
A6	Single	Standard	117	254	3.94	8.55
A7	Double	High Density	185	273	3.66	5.41
A8	Single	Standard	117	254	3.94	8.55
AB	Double	Standard	139	205	4.88	7.19
AG	Single	Standard	117	254	3.94	8.55
AJ	Double	Standard	139	205	4.88	7.19
AQ	Double	Standard	139	205	4.88	7.19
AU	Double	Standard	139	205	4.88	7.19
AU	Single	Standard	117	254	3.94	8.55
B1	Single	Standard	117	254	3.94	8.55
B2	Single	Standard	117	254	3.94	8.55
B2	Double	Standard	139	205	4.88	7.19
B4	Single	Standard	117	254	3.94	8.55
B6	Single	Standard	117	254	3.94	8.55
BC	Double	Standard	139	205	4.88	7.19
BE	Double	Standard	139	205	4.88	7.19
BE	Single	Standard	117	254	3.94	8.55
BJ	Single	Standard	117	254	3.94	8.55
BQ	Single	Standard	117	254	3.94	8.55
C1	Single	Standard	117	254	3.94	8.55
C1	Single	Standard	117	254	4.88	7.19
C2	Double	Standard	139	205	3.94	8.55
C4	Double	Standard	139	205	3.94	8.55
C4	Single	Standard	117	254	2.96	6.41
C5	Single	High Density	156	338	3.94	8.55
C6	Single	Standard	117	254	3.94	8.55
C6	Single	Standard	117	254	4.88	7.19
CS	Double	Standard	139	205	3.94	8.55
CT	Single	Standard	117	254	3.94	8.55
CT	Single	Standard	117	254	3.66	5.41
CU	Double	High Density	185	273	3.66	5.41
CV	Double	High Density	185	273	3.94	8.55
CV	Single	Standard	117	254	3.94	8.55
CW	Double	High Density	185	273	3.66	5.41
D1	Double	High Density	185	273	3.94	8.55
D1	Single	Standard	117	254	3.94	8.55
D4	Single	Standard	117	254	3.94	8.55
D5	Single	High Density	156	338	2.96	6.41
D5	Single	High Density	156	338	3.94	8.55
DA	Single	Standard	117	254	3.94	8.55
DA	Single	Standard	117	254	3.66	5.41
DE	Double	High Density	185	273	3.66	5.41
DE	Double	High Density	185	273	3.94	8.55
E1	Single	Standard	117	254	3.94	8.55
E1	Single	Standard	117	254	2.96	6.41
E5	Single	High Density	156	338	2.96	6.41
E5	Single	High Density	156	338	3.94	8.55
F1	Single	Standard	117	254	3.94	8.55
F1	Single	Standard	117	254	4.88	7.19
F2	Double	Standard	139	205	4.88	7.19
F2	Double	Standard	139	205	4.88	7.19
F4	Double	Standard	139	205	4.88	7.19
F4	Double	Standard	139	205	3.94	8.55
F6	Single	Standard	117	254	4.88	7.19
F6	Single	Standard	117	254	4.88	7.19
F7	Double	High Density	139	205	3.94	8.55
G1	Double	High Density	139	205	3.94	8.55
G1	Single	Standard	117	254	3.94	8.55
G4	Single	Standard	117	254	3.94	8.55
H1	Single	Standard	117	254	3.94	8.55
H1	Single	Standard	117	254	4.88	7.19
H2	Double	Standard	139	205	4.88	7.19
H2	Double	Standard	139	205	4.88	7.19
H4	Double	Standard	139	205	4.88	7.19
H4	Double	Standard	139	205	3.94	8.55
H6	Single	Standard	117	254	3.94	8.55
H6	Single	Standard	117	254	3.66	5.41
H7	Double	High Density	185	273	3.66	5.41