

MINI-ROCK CRAWLER



1/18TH SCALE READY-TO-RUN MINI-ROCK CRAWLER

Owner's Manual

Thank you for choosing the Mini-Rock Crawler from Losi. This guide contains the basic instructions for operating your new Mini-Rock Crawler. While the Mini-Rock Crawler is great for first-time RC drivers, it does require some mechanical experience and/or parental supervision for drivers under 14. It is critical that you read all of the instructions in order to operate your model correctly and avoid unnecessary damage. Please take a moment to look over all the printed materials before operating your new Mini-Rock Crawler.



GO REGISTER YOUR PRODUCT ONLINE

Losi, a division of Horizon Hobby, wants to ensure that you get maximum enjoyment from your 1/18 Mini-Rock Crawler.

We strongly encourage you to register your product using the online Product Registration tool so we can notify you when there are updates, tech tips, new option parts, or service bulletins available for your product.

Log onto WWW.LOSI.COM to complete the Product Registration form.

Not responsible for errors. All prices subject to change without notice.
Losi, a Division of Horizon Hobby, Inc.

Safety Precautions

This is a sophisticated radio controlled model that must be operated with caution and common sense. Failure to operate your Mini-Rock Crawler in a safe and responsible manner could result in damage to the model and property. The Mini-Rock Crawler is not intended for use by children without direct adult supervision. Losi and Horizon Hobby shall not be liable for any loss or damages, whether direct, indirect, special, incidental, or consequential, arising from the use, misuse, or abuse of this product or any product required to operate it.

- This model is controlled by a radio signal subject to interference from many sources outside your control. This interference may cause momentary loss of control, so it is advisable to always keep some distance in all directions around your model as a safety margin to avoid collisions.
- Always operate your model in an open area away from cars, traffic and people.
- Avoid running your model in the street where damage can occur.
- Never run your Mini-Rock Crawler with low transmitter batteries.
- Carefully follow the directions and warnings for this and any optional support equipment.
- Keep all chemicals, small parts and anything electrical out of the reach of children.

Tools and Items You Will Find Handy

- Soft bristle brush for cleaning
- 5.5mm nut driver for the wheel nuts.
- #0 or #1 Phillips screwdriver
- .050-inch Allen Wrench (LOSA99100)

Note: Use only Losi tools or other high-quality tools. Use of inexpensive tools can cause damage to the small screws and parts used on this type of model.



The Radio System

The following is an overview of the various functions and adjustments found on the Mini-Rock Crawler radio system. Since the Mini-Rock Crawler operates on a radio signal you control, it is important for you to read and understand about all of these functions and adjustments before driving.

The Receiver

1. Throttle Port: Where the Electronic Speed Control (ESC) plugs in.
2. Steering Port: Where the steering servo(s) plugs in.
3. Bind Port: Used to "bind" the receiver to the transmitter.
4. Indicator Light: Shows that a frequency/channel is being received.

The Electronic Speed Controller (ESC)

1. On/Off Switch: Powers the receiver and ESC.
2. Setup Button and Indicator Light: Used for resetting the ESC.
3. Battery Lead: Connects to the battery pack for power.
4. Motor Lead: Connects to the wire leads from the motor.

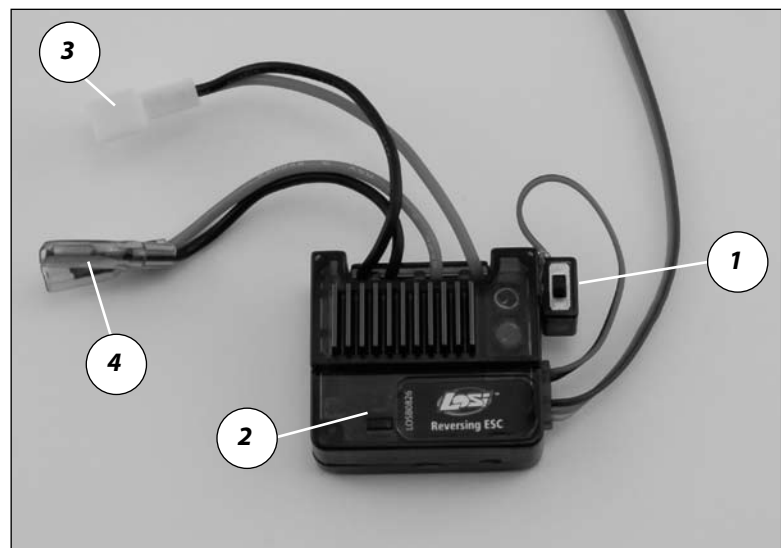
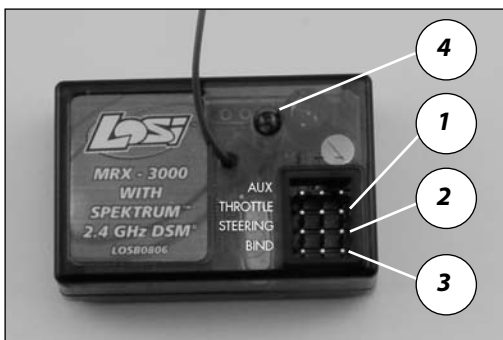

The Transmitter

1. Steering Wheel: Controls direction (left/right) of the model.
2. Throttle Trigger: Controls speed and direction (forward/reverse) of the model.
3. Antenna: Transmits signal to the model.
4. On/Off Switch: Turns the power on for the transmitter operation.
5. Indicator Lights: Green (top) light indicates adequate battery power. Red (bottom) light indicates signal strength.
6. Steering Trim (ST. TRIM): Adjusts the "hands off" direction of the model.
7. Throttle Trim (TH. TRIM): Adjusts the motor speed to stop at neutral.
8. Steering Rate: Adjusts amount front wheels move when the steering wheel is turned left or right.
9. Steering Reverse Switch (ST. REV): Reverses the function of the steering when the wheel is turned left or right.
10. Throttle Reverse Switch (TH. REV): Reverses the function of the speed control when pulled back or pushed forward.
11. Bottom Cover: Covers and holds the batteries powering the transmitter.

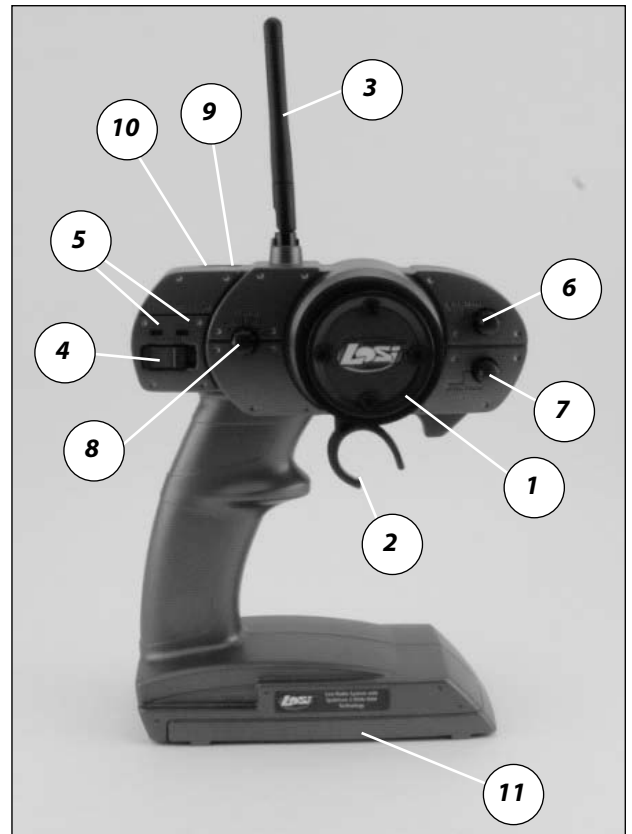

Re-Binding the Transmitter to the Receiver

The Losi™ DSM® radio system included in the Mini-Rock Crawler operates on 2.4GHz, and provides 79 different channels, which are automatically selected when the transmitter and vehicle are turned on. The communication between the transmitter and receiver starts in the few seconds after the transmitter and vehicle are both turned on. This is called the "binding process." The Losi DSM radio system will not interfere with previous technology radio systems that operate on 27MHz or 75MHz frequencies and you will not receive any interference from them.

Although set at the factory, below are the steps required to re-bind your transmitter to the receiver should the need arise. During the bind process there is a unique ID from the transmitter communicated to the receiver to ensure trouble free radio operation.

Steps to Re-Bind the Receiver to the Transmitter

1. Ensure that the transmitter and vehicle are both turned off.
2. Using the supplied Bind plug (which looks like a standard receiver plug with a wire loop installed) insert the plug into the receiver slot labeled "BIND". Looking down on the receiver this slot would be below the LED and is the furthest from the LED, or nearest to the corner of the receiver.

Note: You do not need to remove any of the other plugs to re-bind.

3. With the Bind plug installed, turn on the vehicle. Notice a blinking orange LED within the receiver
4. Now you are ready to turn on the transmitter. You should notice on the back of the transmitter a similar blinking orange LED under the translucent cover.
5. Both the receiver and transmitter orange LED will stop blinking and become solid indicating they have "bound" themselves together.
6. Please turn off both the vehicle and transmitter to remove the Bind plug from the receiver. Failing to remove the Bind plug will cause the transmitter to attempt to rebind every time you turn on the vehicle and transmitter.
7. Turn on both the vehicle and transmitter to ensure operation. If the transmitter does not control the vehicle, please repeat steps 1 to 6. Should this not correct the problem please call Horizon Service/Repair for further assistance.
8. The Bind process is complete. Your vehicle's radio system should be ready for use.



Resetting the ESC

The ESC comes from the factory preset and ready for use. If for some reason you should need to reset the ESC, use the following instructions.

1. Turn on the transmitter and ESC. Press the setup button—both the RED and GREEN LEDs will come on.
2. Pull the throttle trigger all the way back (full speed) and press the setup button once—only the GREEN LED will come on.
3. Push the throttle trigger full forward (brake/reverse) and push the setup button once—only the RED LED will come on.
4. Let the throttle trigger return to the neutral (center) position and press the setup button once more to save the program and exit setup mode—only the GREEN LED will be on.

Notes:

- A: If the receiver does not receive a signal from the Transmitter, the ESC will not enter the Program mode.
- B: While in Program mode, the motor will not run.
- C: If the setup button is not pressed for 20 seconds while in the Program mode, the ESC will exit the Program mode and the data will be saved.

Chassis Tuning

The following are simple adjustments and easily maintained settings to assure proper operation and performance. It is advised when making any adjustment that you do so in small increments and always check for other parts of the chassis that are affected.

Slipper Adjustments

The Mini-Rock Crawler is equipped with a slipper device offering both traction control and protection for the transmission. The slipper is primarily used to help absorb sudden impacts on the drivetrain or when using more powerful aftermarket motors and/or battery packs. Additionally, it can be used to smooth out the flow of power to the wheels. Adjustment is made by turning the 3mm adjustment nut clockwise (to the right) to reduce the slip, or counterclockwise (to the left) to increase the slip. As you punch the throttle, the slipper should slip no more than an inch as it accelerates. With the included motor and battery pack it should slip just a little. Make sure you replace the gear cover before running.

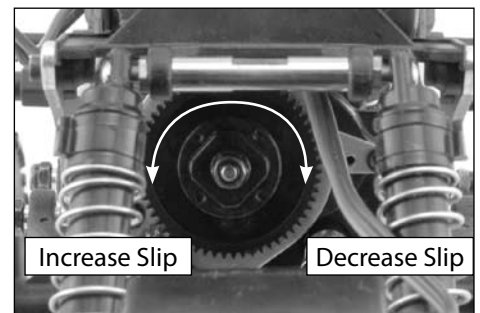

Steering Rate

Your transmitter is equipped with a steering rate control to the left of the steering wheel. This advanced feature, usually found only on competition-type radios, allows you to adjust the amount the front tires move when you turn the steering wheel.

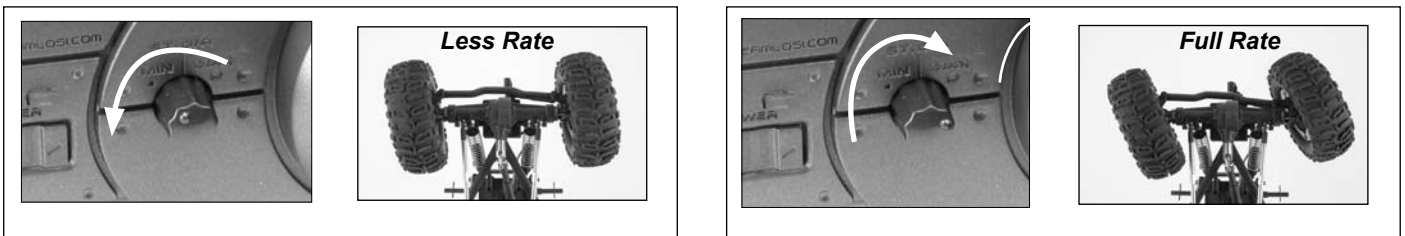

Steering Servo Saver Removal

The Mini-Rock Crawler steering servo comes with a servo saver installed. As your rock crawling skills improve, we have included a steering arm that eliminates the servo saver. Although this setup provides more precise steering, it does put your servo gears at risk for breakage. Use caution when the steering servo is under severe loads.



1. Center servo saver arm



2. Remove servo saver arm assembly from the servo. Remove the steering ball stud and install into solid servo arm.



3. With servo output shaft still centered, install solid servo arm with the shorter screw supplied and attach steering linkage.

Changing the Pinion Gear/Gear Ratio

Before you change the pinion gear ask yourself why you are doing it. In general, if you change to a larger pinion the wheel speed will increase but you will see less acceleration and run time. This would only be advisable for low traction climbs. Changing to a smaller pinion will give you quicker acceleration and possibly a bit longer run time but a little less wheel speed. This would be good for high traction rock climbs. The pinion on the Mini-Rock Crawler offers the best balance of both. To change the pinion, remove the gear cover, loosen the motor screws and slide the motor back. Use the included 1.5mm allen wrench to loosen the pinion setscrew. Place the new pinion on the end of the motor shaft and, using the flat of the pliers or a similar flat tool, push it on to the same position as the one removed. See Setting the Gear Mesh below. Your Mini-Rock Crawler comes equipped with a 14-tooth pinion which provides an overall ratio of 86:1. If you increase the pinion size to a 15-tooth gear, the ratio will change to 80:1 to decrease the pinion size to a 13-tooth will be 92:1.

Warning: When running aftermarket motors, check with the motor manufacturer for correct gearing. Never over-gear the motor as it can cause overheating, damaging it and the speed control.

Setting the Gear Mesh

The motor screws should be slightly loose. Slide the motor forward allowing the pinion gear to mesh with the spur gear. Snug (not tight) the bottom motor screw and try rocking the spur back and forth. There is a slight bit of movement before the motor is forced to turn over. If not, pull the top of the motor back slightly and recheck. If there is too much slop between the gears, push the top of the motor forward. When set properly the wheels can be spun forward freely with very little noise. Make sure to tighten both motor screws and replace the gear cover before running.



Tuning Tips

Weight: Adding weight to the front wheels of the Mini-Rock Crawler will help increase traction and lower the over center of gravity. Using the LOSA99201 Self Stick weights, carefully cut each piece in half and place inside the wheel as pictured. It is important that the wheel weights be evenly placed inside the wheel to ensure that it is balanced.

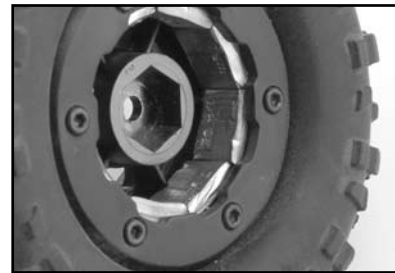

Shock Oil and Springs

The Mini-Rock Crawler shocks are filled with Losi 30wt shock fluid. By switching to thinner shock fluid, the Mini-Rock Crawler will have more traction, quicker weight transfer and softer dampening. Doing the opposite will cause the Mini-Rock Crawler to react more slowly to input and have slower weight transfer. Adjusting these settings will help adapt the Mini-Rock Crawler to your conditions. Please note, the Mini-Rock Crawler comes from the factory with a stiffer rear spring to help minimize "Torque Flex" often found in 4wd driver rock crawlers.

Cleaning

Performance can be hindered if dirt gets in any of the moving suspension parts. Use compressed air, a soft paintbrush, or toothbrush to remove dust or dirt. Avoid using solvents or chemicals as they can actually wash dirt into the bearings or moving parts as well as cause damage to the electronics.

Rebuilding/Refilling the Shocks

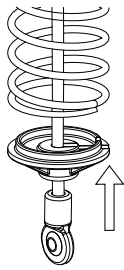

Step 1
After removing the shock, push up on the lower spring cup and remove it from the shaft. Remove the spring and preload spacers.

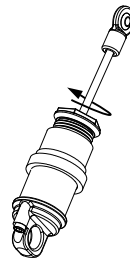

Step 2
Turn the shock upside down and remove the black shock cartridge/shaft assembly from the shock body by turning it counterclockwise.

Note: If you only wish to change or fill the shock fluid, skip to step 5.



Step 3
Remove the top E-clip from the shock shaft. Remove the shock piston. Remove second E-clip. Remove the old cartridge. Put a drop of oil on the shock shaft before installing a new shock cartridge.

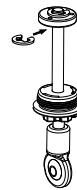

Step 4
Reinstall the lower E-clip. Slide the shock piston onto the shock shaft against the E-clip. Reinstall the top E-clip.



Step 5
If you plan on completely changing the shock fluid (suggested), dump out the old fluid from the shock body. Carefully fill the shock body with fluid to the bottom of the threads inside the shock body. **Note:** Your Mini-Rock Crawler comes with 100wt shock fluid from the factory.



Step 6
Pull the shaft out so the piston is next to the cartridge and reinstall the assembly into the shock body, turn in a clockwise direction until snug—**DO NOT TIGHTEN** yet!

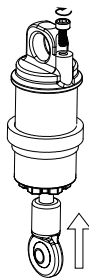

Step 7
Turn the shock over and use a #0 Phillips screwdriver to remove the small bleed screw at the top of the shock. Slowly push the shock shaft up until it stops. Excess fluid should flow out of the bleed hole. Slowly pull the shock shaft halfway back and replace the bleed screw. Use pliers to tighten the cartridge, being careful not to strip the plastic lobes on the cartridge.

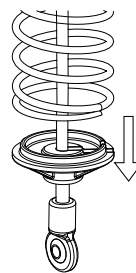

Step 8
Replace the spring and spring cup and test the shock action for smoothness and leaks. Retighten the bleed screw or cartridge if either leaks. Remount the shock on your truck.

Service/Repair

Radio/Speed Control and Motor

If you have any problems other than those covered in the troubleshooting section, please call the electronics service department at (877) 504-0233. They will be able to give your specific problem additional attention and instruct you as to what needs to be done.

Chassis

If you have any questions other than those covered in the troubleshooting or maintenance sections, please call (877) 504-0233.

LOSI DSM Radio System

This device complies with part 15 of the FCC rules. Operation is subject to the following two conditions: (1) This device may not cause harmful interference, and (2) this device must accept any interference received, including interference that may cause undesired operation.

Caution: Changes or modifications not expressly approved by the party responsible for compliance could void the user's authority to operate the equipment.

This product contains a radio transmitter with wireless technology which has been tested and found to be compliant with the applicable regulations governing a radio transmitter in the 2.400 GHz to 2.4835 GHz frequency range.

The following countries associated regulatory agencies recognizing the noted certifications for this product as authorized for sale and use are:

USA - Belgium - Canada - Denmark - Finland - France - Germany - Italy - Netherlands - Spain - Sweden - UK

Warning

An RC model is not a toy! If misused, it can cause serious bodily harm and damage to property. Operate only in open areas and follow all instructions included with your radio and model.

Warranty Information

Warranty Period

Horizon Hobby, Inc., (Horizon) warrants that the Products purchased (the "Product") will be free from defects in materials and workmanship at the date of purchase by the Purchaser.

Limited Warranty

(a) This warranty is limited to the original Purchaser ("Purchaser") and is not transferable. REPAIR OR REPLACEMENT AS PROVIDED UNDER THIS WARRANTY IS THE EXCLUSIVE REMEDY OF THE PURCHASER. This warranty covers only those Products purchased from an authorized Horizon dealer. Third party transactions are not covered by this warranty. Proof of purchase is required for warranty claims. Further, Horizon reserves the right to change or modify this warranty without notice and disclaims all other warranties, express or implied.

(b) Limitations- HORIZON MAKES NO WARRANTY OR REPRESENTATION, EXPRESS OR IMPLIED, ABOUT NON-INFRINGEMENT, MERCHANTABILITY OR FITNESS FOR A PARTICULAR PURPOSE OF THE PRODUCT. THE PURCHASER ACKNOWLEDGES THAT THEY ALONE HAVE DETERMINED THAT THE PRODUCT WILL SUITABLY MEET THE REQUIREMENTS OF THE PURCHASER'S INTENDED USE.

(c) Purchaser Remedy- Horizon's sole obligation hereunder shall be that Horizon will, at its option, (i) repair or (ii) replace, any Product determined by Horizon to be defective. In the event of a defect, these are the Purchaser's exclusive remedies. Horizon reserves the right to inspect any and all equipment involved in a warranty claim. Repair or replacement decisions are at the sole discretion of Horizon. This warranty does not cover cosmetic damage or damage due to acts of God, accident, misuse, abuse, negligence, commercial use, or modification of or to any part of the Product. This warranty does not cover damage due to improper installation, operation, maintenance, or attempted repair by anyone other than Horizon. Return of any goods by Purchaser must be approved in writing by Horizon before shipment.

Damage Limits

HORIZON SHALL NOT BE LIABLE FOR SPECIAL, INDIRECT OR CONSEQUENTIAL DAMAGES, LOSS OF PROFITS OR PRODUCTION OR COMMERCIAL LOSS IN ANY WAY CONNECTED WITH THE PRODUCT, WHETHER SUCH CLAIM IS BASED IN CONTRACT, WARRANTY, NEGLIGENCE, OR STRICT LIABILITY. Further, in no event shall the liability of Horizon exceed the individual price of the Product on which liability is asserted. As Horizon has no control over use, setup, final assembly, modification or misuse, no liability shall be assumed nor accepted for any resulting damage or injury. By the act of use, setup or assembly, the user accepts all resulting liability.

If you as the Purchaser or user are not prepared to accept the liability associated with the use of this Product, you are advised to return this Product immediately in new and unused condition to the place of purchase.

Law: These Terms are governed by Illinois law (without regard to conflict of law principals).

Safety Precautions

This is a sophisticated hobby Product and not a toy. It must be operated with caution and common sense and requires some basic mechanical ability. Failure to operate this Product in a safe and responsible manner could result in injury or damage to the Product or other property. This Product is not intended for use by children without direct adult supervision. The Product manual contains instructions for safety, operation and maintenance. It is essential to read and follow all the instructions and warnings in the manual, prior to assembly, setup or use, in order to operate correctly and avoid damage or injury.

Questions, Assistance, and Repairs

Your local hobby store and/or place of purchase cannot provide warranty support or repair. Once assembly, setup or use of the Product has been started, you must contact Horizon directly. This will enable Horizon to better answer your questions and service you in the event that you may need any assistance. For questions or assistance, please direct your email to productsupport@horizonhobby.com, or call 877.504.0233 toll free to speak to a service technician.

Inspection or Repairs

If this Product needs to be inspected or repaired, please call for a Return Merchandise Authorization (RMA). Pack the Product securely using a shipping carton. Please note that original boxes may be included, but are not designed to withstand the rigors of shipping without additional protection. Ship via a carrier that provides tracking and insurance for lost or damaged parcels, as Horizon is not responsible for merchandise until it arrives and is accepted at our facility. A Service Repair Request is available at www.horizonhobby.com on the "Support" tab. If you do not have internet access, please include a letter with your complete name, street address, email address and phone number where you can be reached during business days, your RMA number, a list of the included items, method of payment for any non-warranty expenses and a brief summary of the problem. Your original sales receipt must also be included for warranty consideration. Be sure your name, address, and RMA number are clearly written on the outside of the shipping carton.

Warranty Inspection and Repairs

To receive warranty service, you must include your original sales receipt verifying the proof-of-purchase date. Provided warranty conditions have been met, your Product will be repaired or replaced free of charge. Repair or replacement decisions are at the sole discretion of Horizon Hobby.

Non-Warranty Repairs

Should your repair not be covered by warranty the repair will be completed and payment will be required without notification or estimate of the expense unless the expense exceeds 50% of the retail purchase cost. By submitting the item for repair you are agreeing to payment of the repair without notification. Repair estimates are available upon request. You must include this request with your repair. Non-warranty repair estimates will be billed a minimum of ½ hour of labor. In addition you will be billed for return freight. Please advise us of your preferred method of payment. Horizon accepts money orders and cashiers checks, as well as Visa, MasterCard, American Express, and Discover cards. If you choose to pay by credit card, please include your credit card number and expiration date. Any repair left unpaid or unclaimed after 90 days will be considered abandoned and will be disposed of accordingly. Please note: non-warranty repair is only available on electronics and model engines. Electronics and engines requiring inspection or repair should be shipped to the following address:

Horizon Service Center
4105 Fieldstone Road
Champaign, Illinois 61822

All other Products requiring warranty inspection or repair should be shipped to the following address:

Horizon Product Support
4105 Fieldstone Road
Champaign, Illinois 61822

Please call 877-504-0233 with any questions or concerns regarding this product or warranty.

Instructions for Disposal of WEEE by Users in the European Union

This product must not be disposed of with other waste. Instead, it is the user's responsibility to dispose of their waste equipment by handing it over to a designated collection point for the recycling of waste electrical and electronic equipment. The separate collection and recycling of your waste equipment at the time of disposal will help to conserve natural resources and ensure that it is recycled in a manner that protects human health and the environment. For more information about where you can drop off your waste equipment for recycling, please contact your local city office, your household waste disposal service or where you purchased the product.



TROUBLESHOOTING GUIDE

• Doesn't operate	Battery not charged or plugged in Receiver switch not "On" Transmitter not "On" or low battery	Charge battery / plug in Turn on receiver switch Turn on / replace batteries
• Motor runs but wheels don't move	Pinion not meshing with spur gear Pinion spinning on motor shaft Slipper too loose Transmission gears stripped Drive pin in axle missing	Adjust pinion/spur mesh Replace pinion gear on motor Check & adjust slipper Replace transmission gears Check & replace
• Steering doesn't work	Servo plug not in receiver Servo gears or motor damaged	Check if plug in/all the way Replace or repair servo
• Won't turn one direction	Servo gears damaged	Replace servo gears
• Motor doesn't run	Motor plugs loose Motor wire broken ESC damaged	Plug in completely Repair or replace as needed Call Electronics Tech
• ESC gets hot	Motor over-gearred Driveline bound up	Put smaller pinion on motor Check wheels & trans for binds
• Poor run time and/or sluggish acceleration	NiMH pack not fully charged Charger not allowing full charge Slipper slipping too much Motor worn out Driveline bound up	Recharge Try another charger Check/adjust slipper Replace motor Check wheels & trans for binds
• Poor range/glitches	Transmitter batteries low Transmitter antenna damaged Battery low in truck Loose plugs or wires	Check & replace as necessary Check & tighten Replace or recharge Check motor and power plugs
• Slipper won't adjust	Drive pin missing in shaft Spur gear face worn out	Replace drive pin Replace spur gear & adjust slipper

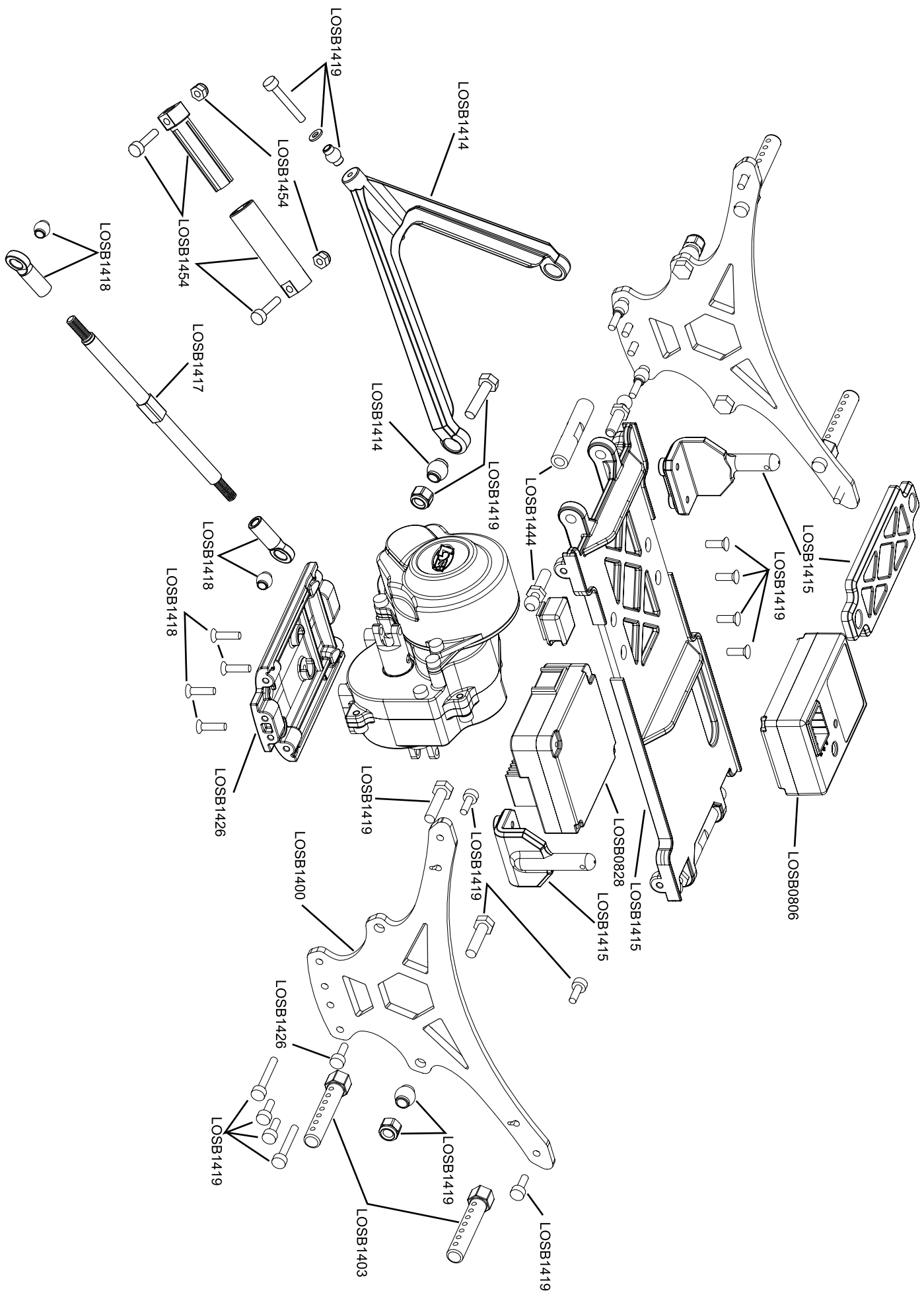

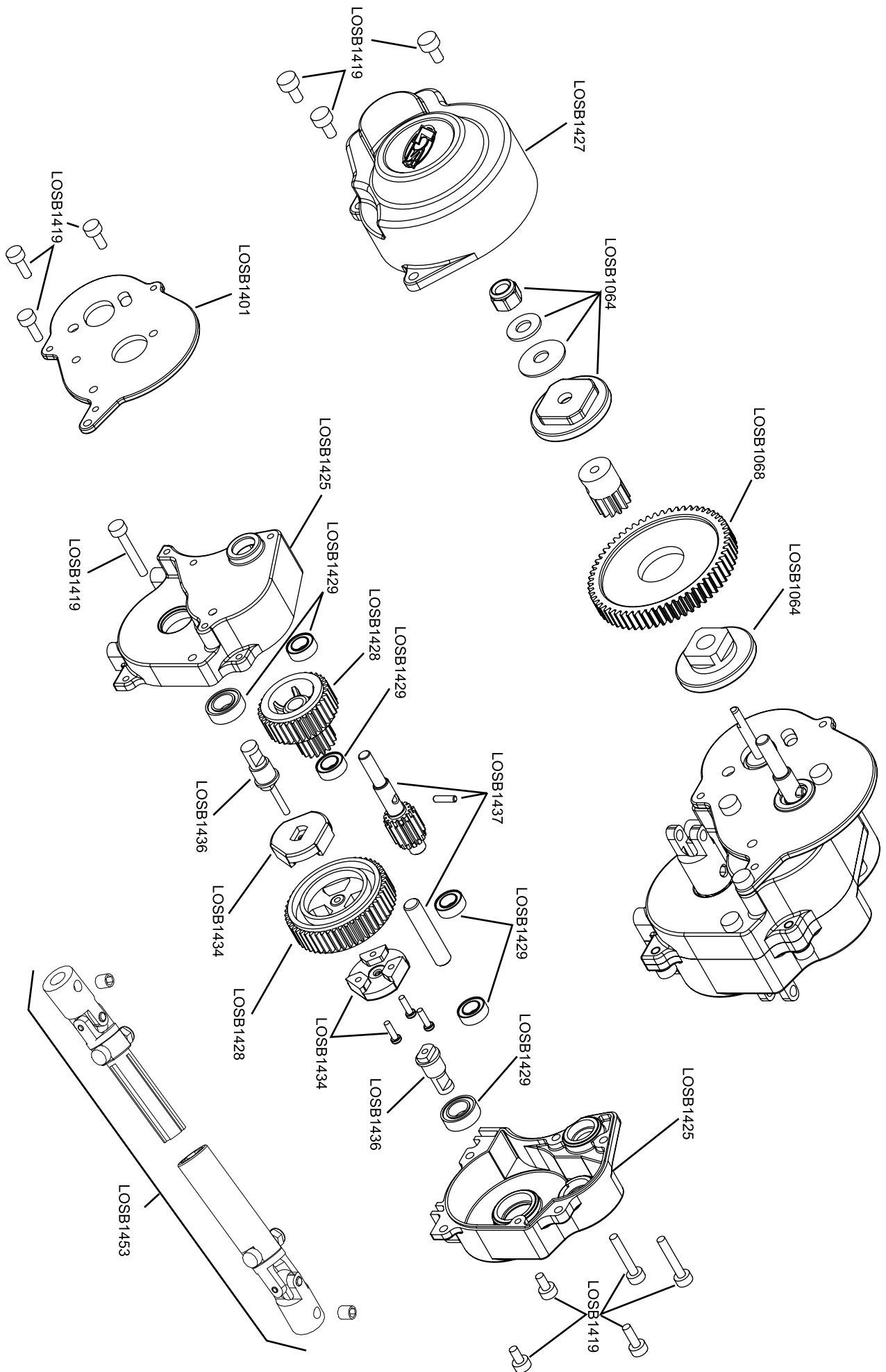

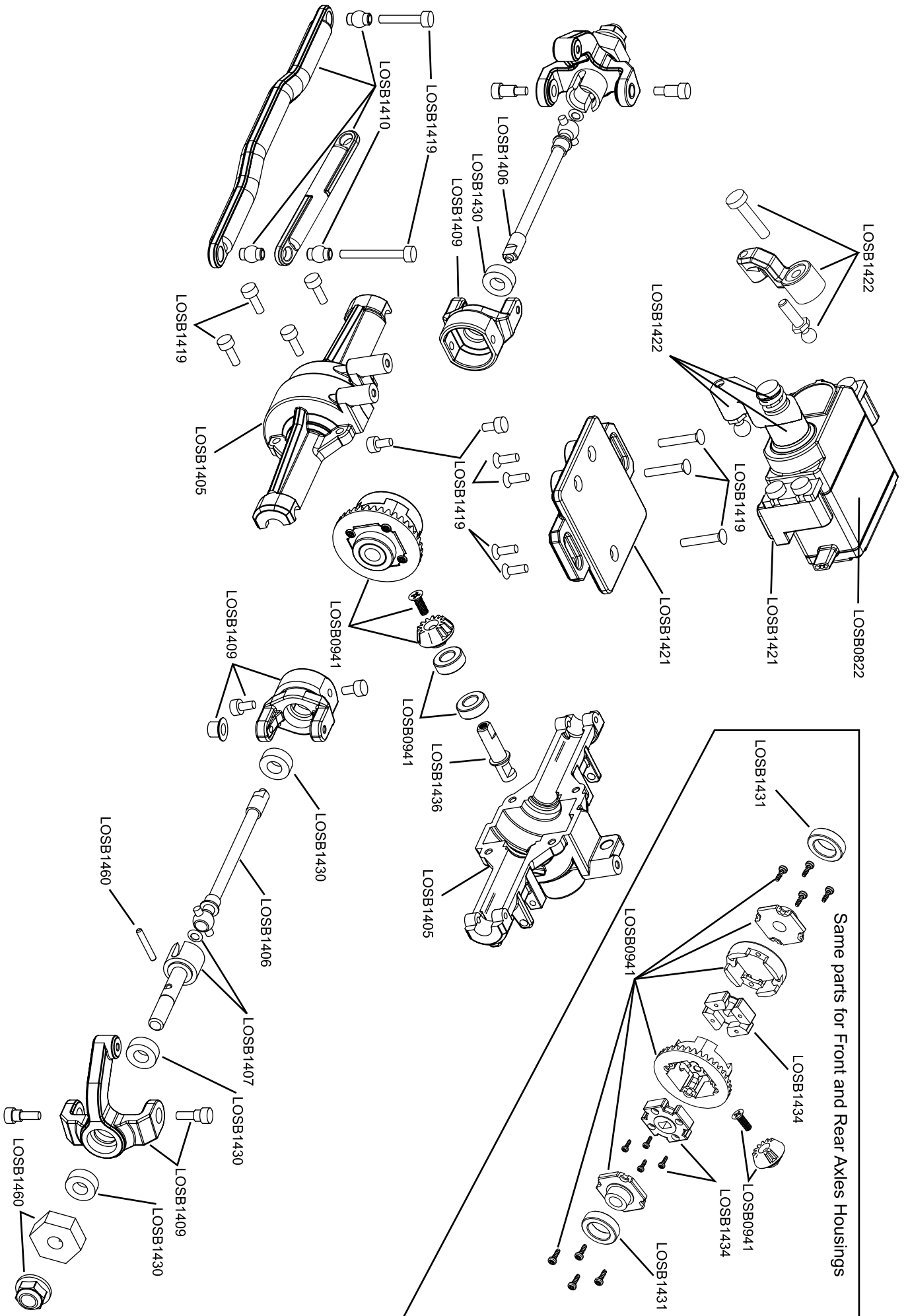

Same parts for Front and Rear Axles Housings

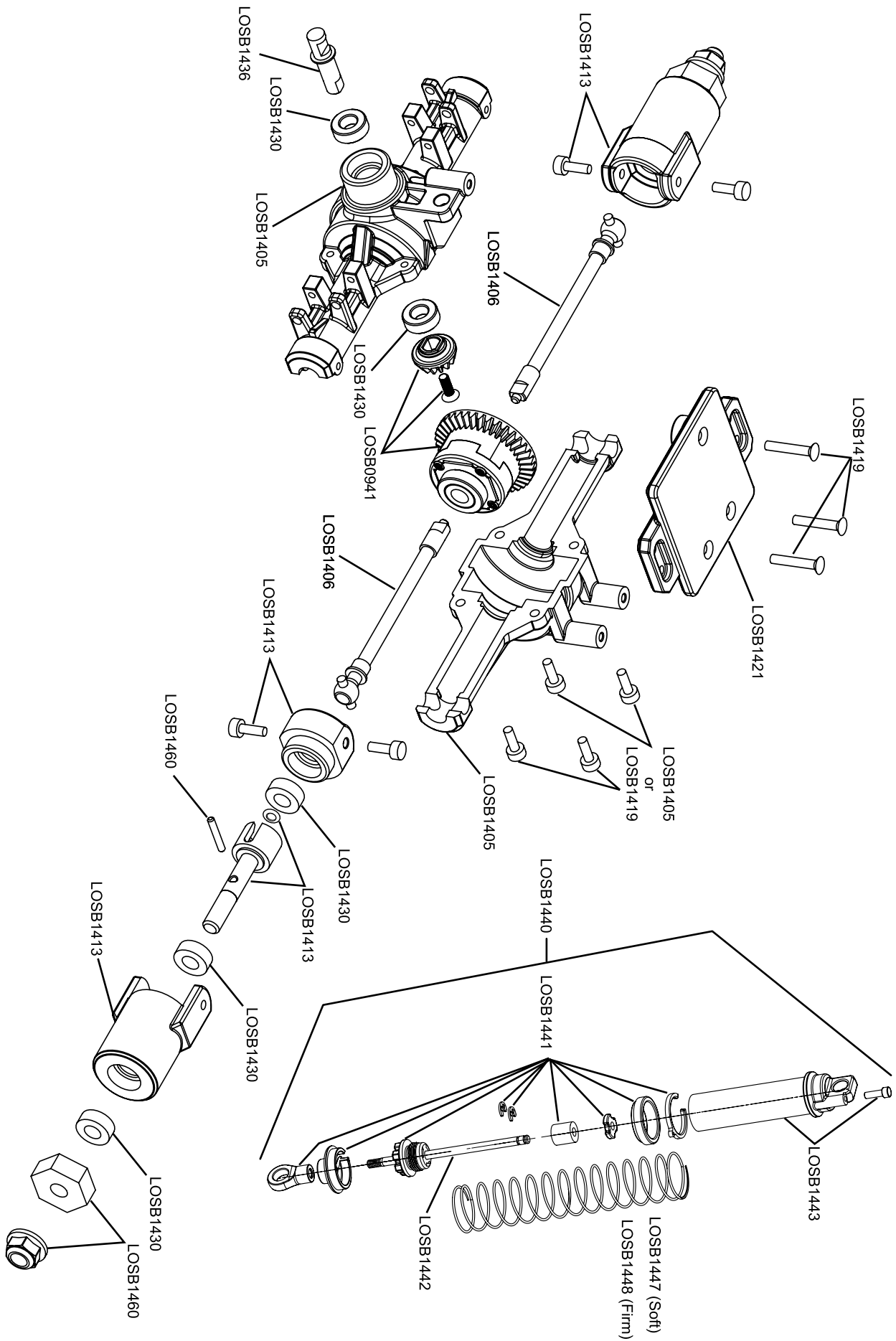

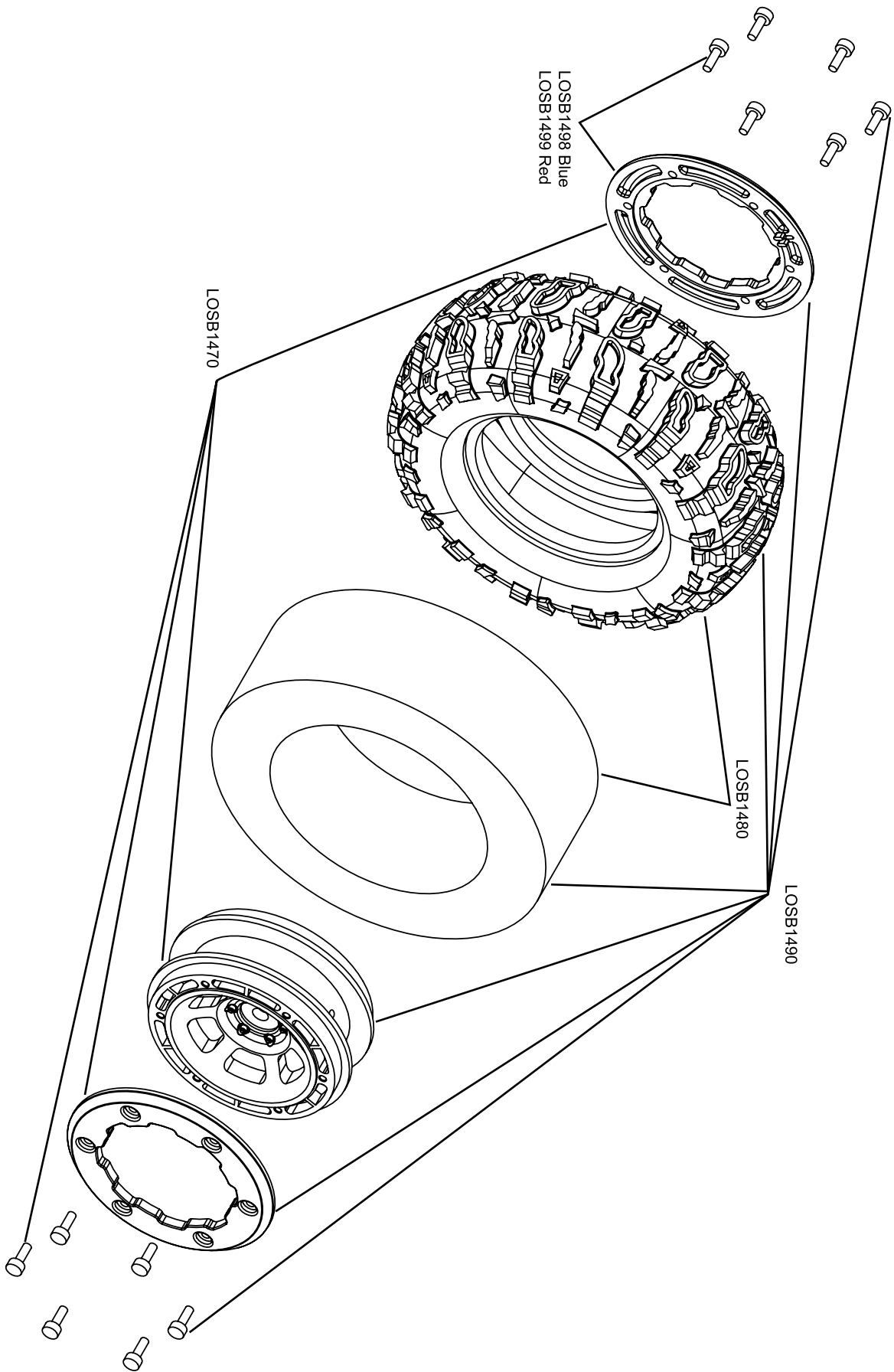

REPLACEMENT PARTS

Item #	Description	Retail
LOSB0805	Losi DSM Transmitter Only	\$69.99
LOSB0806	Losi DSM Receiver.....	\$109.99
LOSB0822	MSX12 Digital Mini Servo	\$29.99
LOSB0823	MSX12 Digital Mini Servo Gear Set	\$3.99
LOSB0828	Mini Rock Crawler ESC Only	\$47.99
LOSB0839	1/18 Mini Rock Crawler Motor:	\$14.99
LOSB0941	Fr/R Metal Diff Gear & Housing set:	\$13.99
LOSB1048	Body Clips (10)	\$1.50
LOSB1064	Slipper Hardware Set.....	\$4.00
LOSB1068	Spur Gear Bag	\$3.50
LOSB1202	7.2v 1100mAh Ni-MH Battery.....	\$39.99
LOSB1376	Mini Rock Crawler Body (Blue).....	\$19.99
LOSB1377	Mini Rock Crawler Body (Red)	\$19.99
LOSB1378	Mini Rock Crawler Body (Black):	\$19.99
LOSB1400	Aluminum Chassis Plate Set:	\$11.99
LOSB1401	Motor Plate.....	\$5.99
LOSB1403	Body Post Set.....	\$4.99
LOSB1405	Axle Housing (2) w/hardware.....	\$9.99
LOSB1406	Axle Shafts (2).....	\$7.99
LOSB1407	Axles (2)	\$7.99
LOSB1409	Front Spindles & Carriers w/hardware	\$7.99
LOSB1410	Steering Links (Long & Short).....	\$7.99
LOSB1413	Rear Hub Set w/hardware.....	\$5.99
LOSB1414	3 Link Connector w/pivot ball.....	\$7.99
LOSB1415	Radio Plate, Battery Mounts & Strap	\$8.99
LOSB1417	Lower Suspension Rods	\$6.99
LOSB1418	Lower Suspension Rod Ends w/pivot ball.....	\$7.99
LOSB1419	Complete Screw Kit.....	\$12.99
LOSB1421	Servo Plates & Mounts	\$6.99
LOSB1422	Servo Saver & Arm Set.....	\$6.99
LOSB1425	Center Transmission Case Set.....	\$5.99
LOSB1426	Transmission Skid Plate	\$4.99

Item #	Description	Retail
LOSB1427	Center Transmission Gear Cover	\$5.99
LOSB1428	Center Transmission Gear Set.....	\$5.99
LOSB1429	Center Transmission Bearing Set.....	\$19.99
LOSB1430	Bearing 4x8x3mm (Axle Bearing)	\$7.99
LOSB1431	Bearing 7x11x3 (Diff Bearing).....	\$5.99
LOSB1434	Center & Diff Lockers (Plastic).....	\$6.99
LOSB1436	Output Shaft Set (Axles & Center Diff)	\$7.99
LOSB1437	Top Shaft & Idler Shaft	\$6.99
LOSB1440	Assembled Shocks (2)	\$15.99
LOSB1441	Shock Rebuild Kit (2).....	\$5.99
LOSB1442	Shocks Shafts (2)	\$5.99
LOSB1443	Shock Body (2)	\$5.99
LOSB1444	Ball Stud Long & Shock Mounting Brace.....	\$6.99
LOSB1447	Shock Spring Set (Soft)	\$2.99
LOSB1448	Shock Spring Set (Firm)	\$2.99
LOSB1453	Assembled Universal Joints/Slider shafts	\$17.99
LOSB1454	Slider Shafts Set (plastic)	\$7.99
LOSB1460	12mm Wheel Hex Set w/hardware.....	\$6.99
LOSB1470	Chrome Wheels	\$8.99
LOSB1480	1.9" Mini-Rock Claws Tires (2).....	\$13.99
LOSB1490	1.9" Mini-Rock Claws Glued(2) Chrome Wheels ..	\$22.99
LOSB1498	Wheel Rings (8) Blue	\$7.99
LOSB1499	Wheel Rings (8) Red	\$7.99

OPTION PARTS

LOSB1320	Mini-Rock Crawler Clear Body w/stickers.....	\$16.99
LOSB1321	1/18th Grappler Body w/Stickers & Mask.....	\$18.99
LOSB1400B	Blue Anodized Chassis Plate Set Lazer etch	\$15.99
LOSB1400R	Red Anodized Chassis Plate Set Lazer etch	\$15.99
LOSB1461	Aluminum 12mm Hex Set	\$14.99
LOSB1471	Black Chrome Wheels (2).....	\$8.99
LOSB9603	1-3 Cell LiPo Charger	\$54.99
LOSB9605	Intelligent LiPo Balance Charger, 1-5 Cells	\$139.99
LOSB9833	7.4V 1650mAh 2-Cell LiPo 20C: Slider	\$64.99



Losi
A Division of Horizon Hobby, Inc.
4105 Fieldstone, Champaign, IL 61821
www.Losi.com
1-877-504-0233