



Owner's Manual



Specifications

Hull Length.....	14 in (356mm)
Beam.....	4.125 in (105mm)
Motor.....	Hi-Performance 380-Size
Radio System.....	Pro Boat 2-Channel AM 27MHz Pistol-Grip
Drive System.....	Direct Drive
Steering System.....	Steerable Drive System
Battery	PRB1202 7.2V Ni-MH

Introduction

Thank you for purchasing the Pro Boat™ Mini-C™ Ready-To-Run boat. Please read these instructions carefully before attempting to operate your boat.

The Mini-C comes ready-to-run with the Pro Boat 27MHz AM radio system and electronic speed controller already installed. All assembly and building is done at the factory, allowing you to quickly get your boat running.

Table of Contents

Introduction.....	2
Table of Contents	2
General Guidelines	3
Additional Required Items	3
Inspection	3
Contents	4
Getting Started	4
Charging the Motor Battery	5
Installing the Transmitter Batteries	6
Installing the Antenna Tube	7
Installing the Motor Battery	8
Checking the Radio System	9
Testing Your Boat in the Water	11
Handling Adjustments	11
Maintenance	12
Replacement Parts.....	14
Identification of Components	15
Instructions for Disposal of WEEE by Users in the European Union.....	16
Warranty Information.....	16

General Guidelines

It is important that you read and follow this instruction manual before you run this exciting boat. Failure to read and understand the manual could result in personal injury, property damage or permanent damage to your boat. It is also important to run your boat responsibly. With proper care and maintenance, you will be able to proudly enjoy your Mini-C for many years to come.

When operating the boat, stay clear of people, full-scale boats, stationary objects and wildlife. It is preferable to operate the Mini-C in low-wake, low-wind conditions and in areas free of people, wildlife and objects.

Before you operate your model, make sure your frequency is clear. If someone is operating on the same frequency, both models could go out of control, possibly causing damage to the models or to others. Check all of the hardware and the propeller for damage and loose screws before and after each run.

Additional Required Items

You will need to purchase the following to get your boat on the water:

- 8 AA alkaline batteries for the radio transmitter

Inspection

Carefully remove the boat, radio transmitter, battery and charger from the box. Inspect all items to make sure no damage is present. If you notice damage is present, please contact the hobby shop where you purchased your model.

Contents

- Assembled Mini-C RTR
- Pro Boat radio transmitter
- Boat stand
- Battery
- Battery Charger



Getting Started

Before you start running your new Mini-C, it is absolutely necessary that you read through all of the operating instructions to prevent unnecessary damage and get the maximum enjoyment from your boat.

Charging the Motor Battery

Caution: The Ni-MH charger is for indoor use only. Never expose the charger to moisture. Do not leave the battery pack unattended while charging.

Plug the battery charger into a standard 110/120V AC wall outlet.



Connect a fully discharged battery to the charge plug.



Charge the battery for 1–2 hours before use. Never leave the battery pack charging for more than 2 hours or serious damage or fire may occur. When the battery is warm, disconnect from the charger.

Do not leave the battery pack unattended while charging.

Installing the Transmitter Batteries

Remove the transmitter battery cover by sliding the cover from left to right. Remove the battery tray from the transmitter.

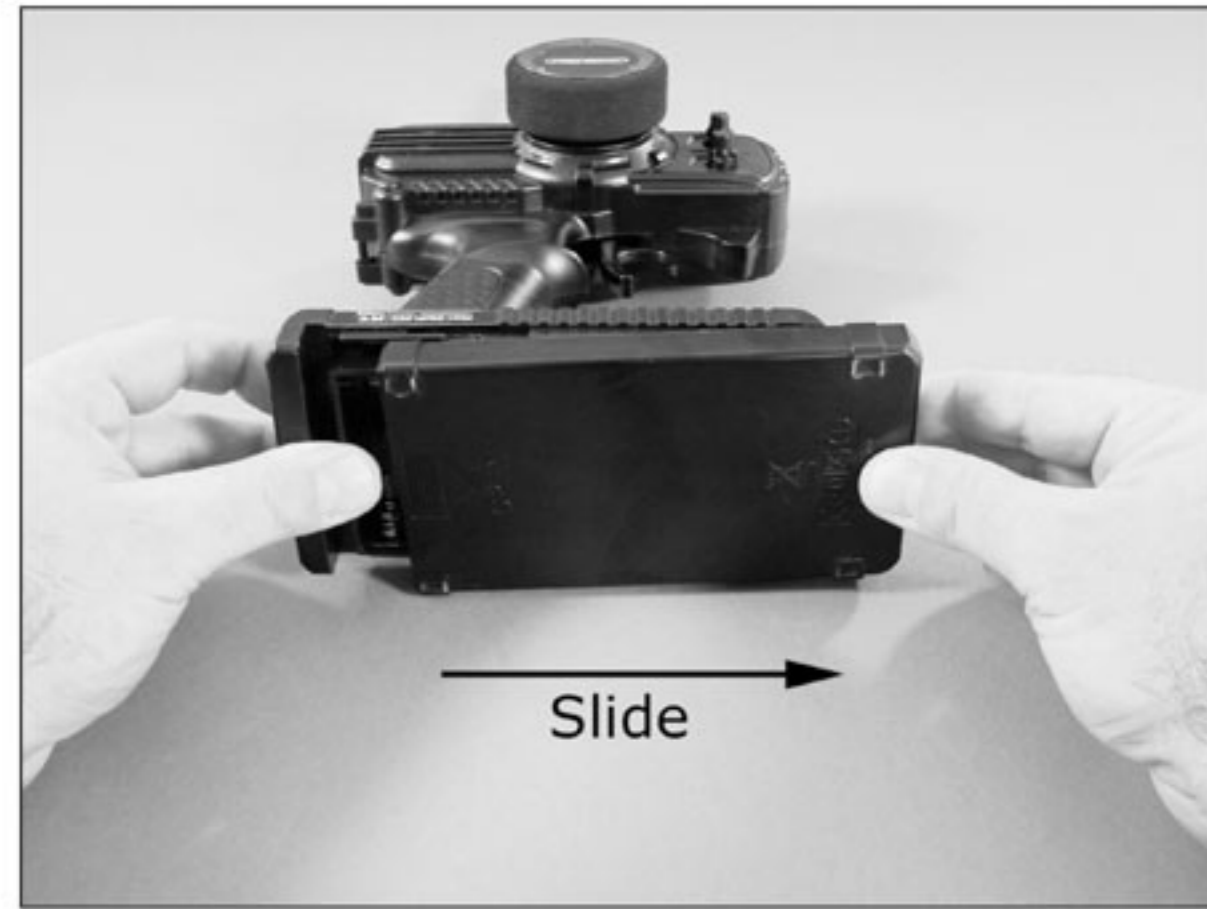

Once all 8 batteries have been installed, reinstall the battery tray into the transmitter.



Install the battery cover by sliding it on from right to left.

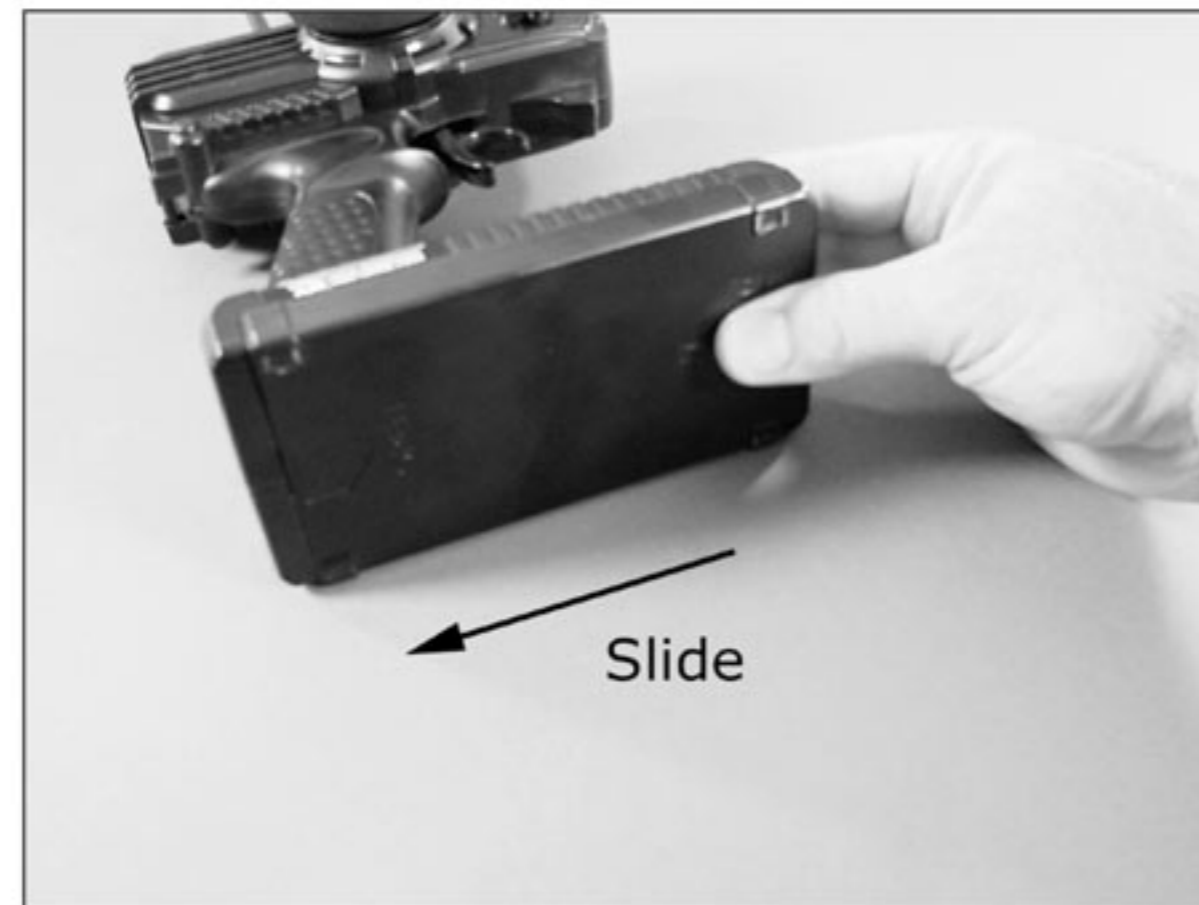

Install eight (8) AA batteries into the battery holder. Pay close attention to the correct direction of the positive (+) and negative (-) ends as marked in the tray.



Installing the Antenna Tube

Remove the hatch from the boat by lifting it at the rear and sliding it back. A magnet holds the hatch at the back of the boat.

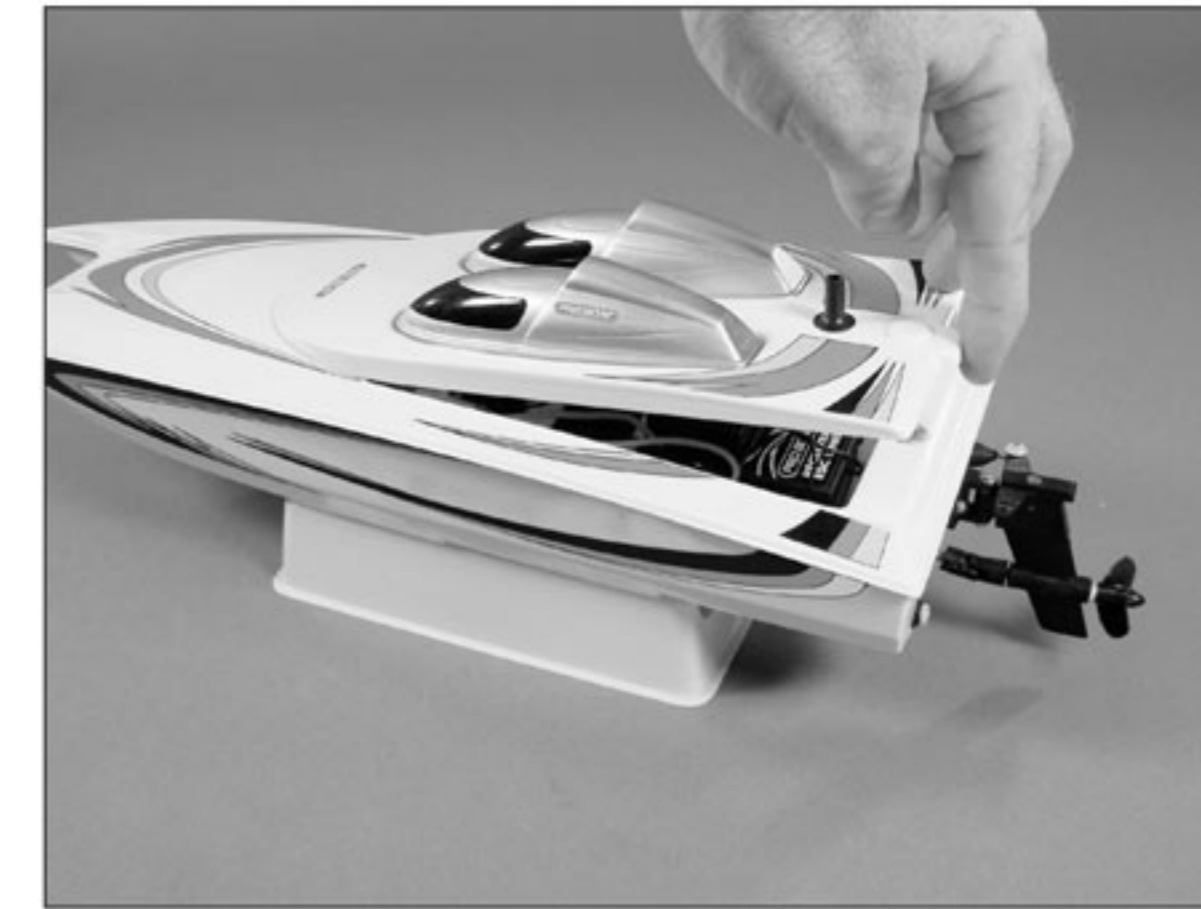

Insert the antenna wire through the antenna mount.

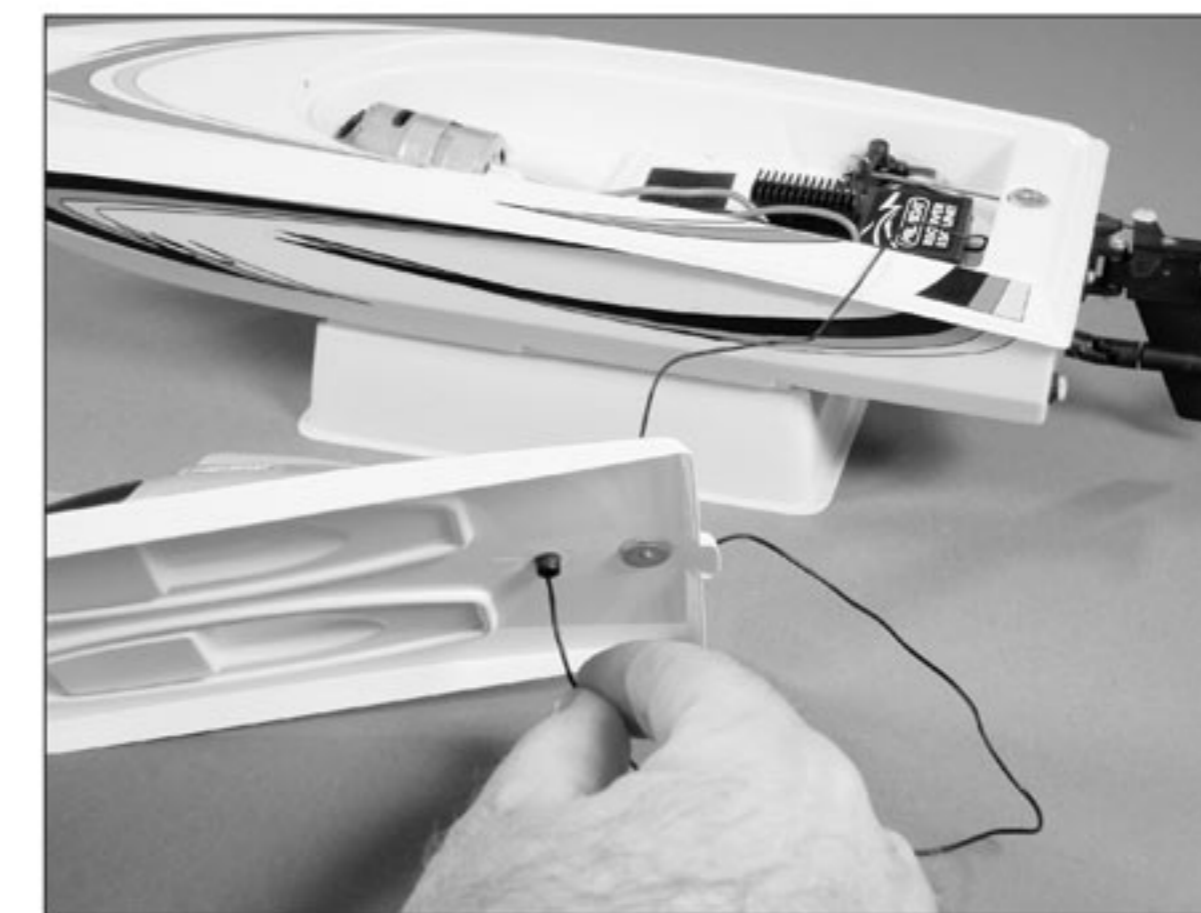

Slide the antenna wire into the antenna tube, pushing it through until it comes out the other end.

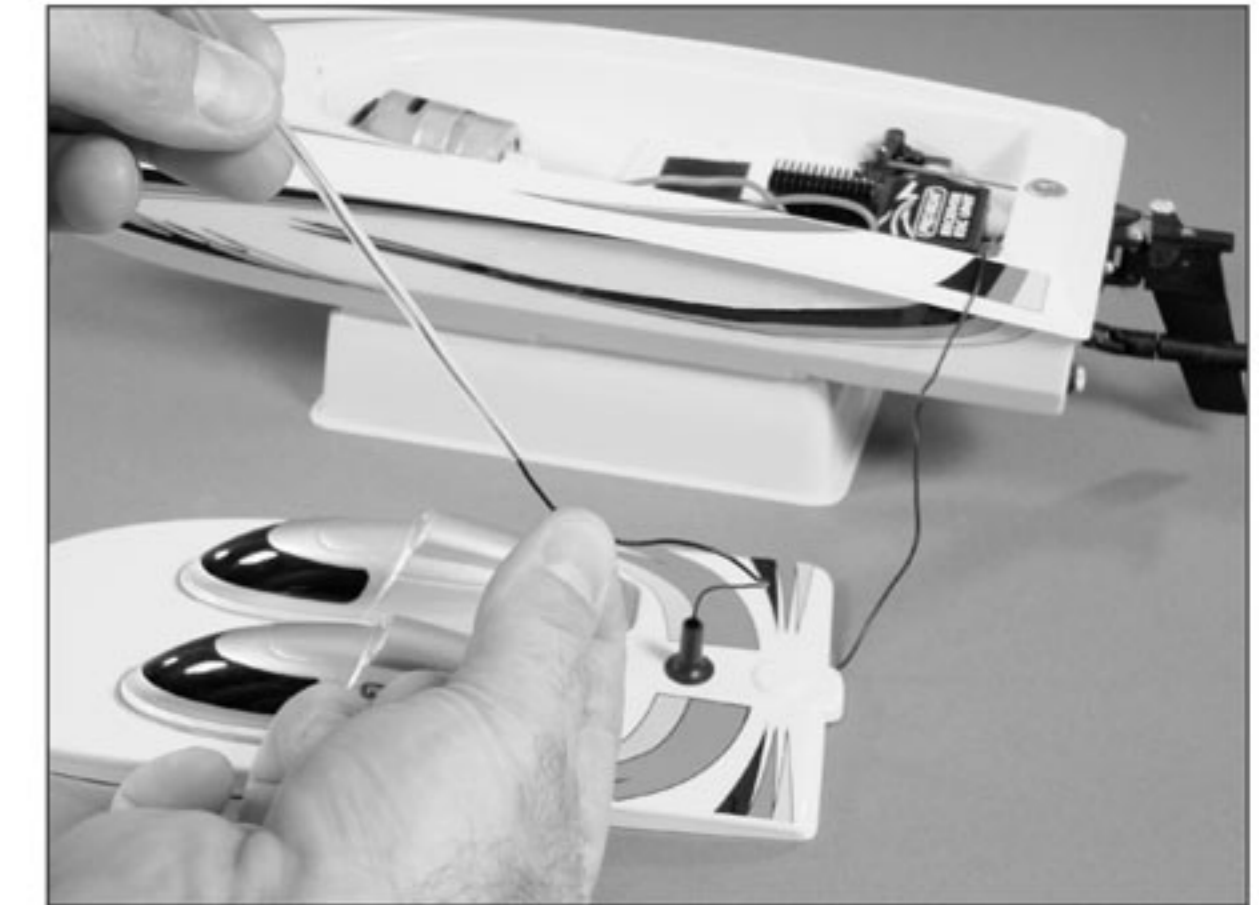

Slide the antenna cap onto the antenna tube to secure the wire in the tube.



Push the antenna tube into the antenna mount.

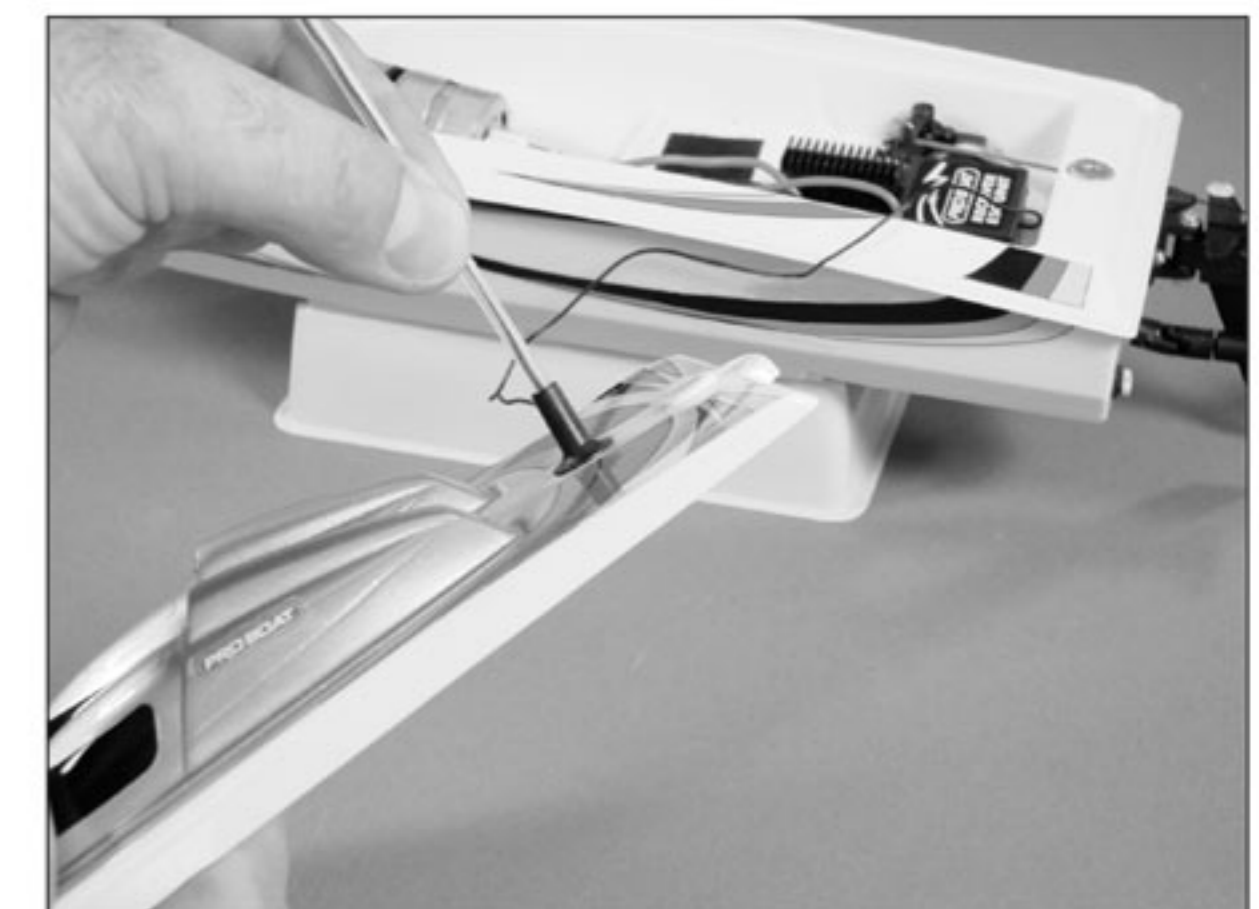

Installing the Motor Battery

Once the battery is charged, apply the supplied hook and loop tape to the hull.



Attach the remaining hook and loop to the battery as shown.

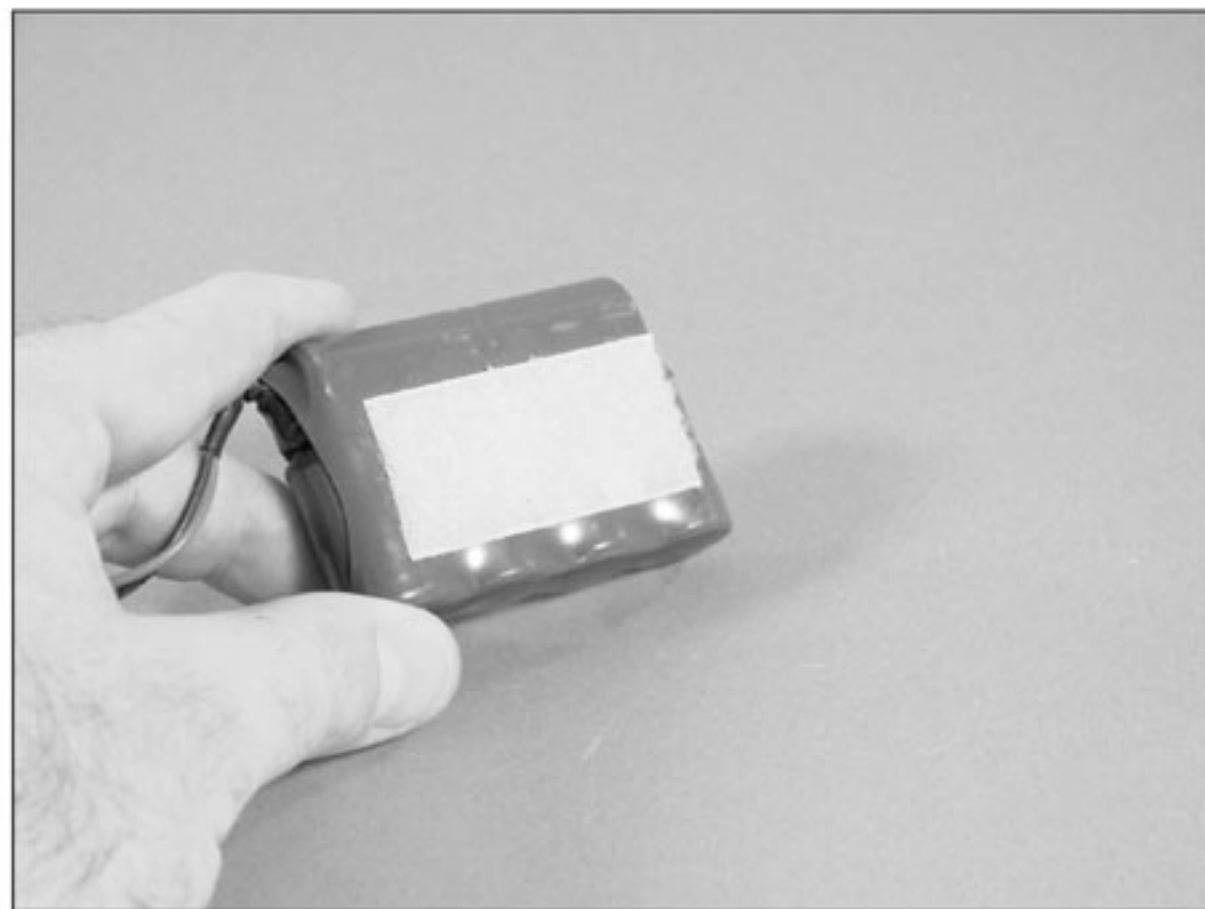

Install the battery pack into the hull as shown.

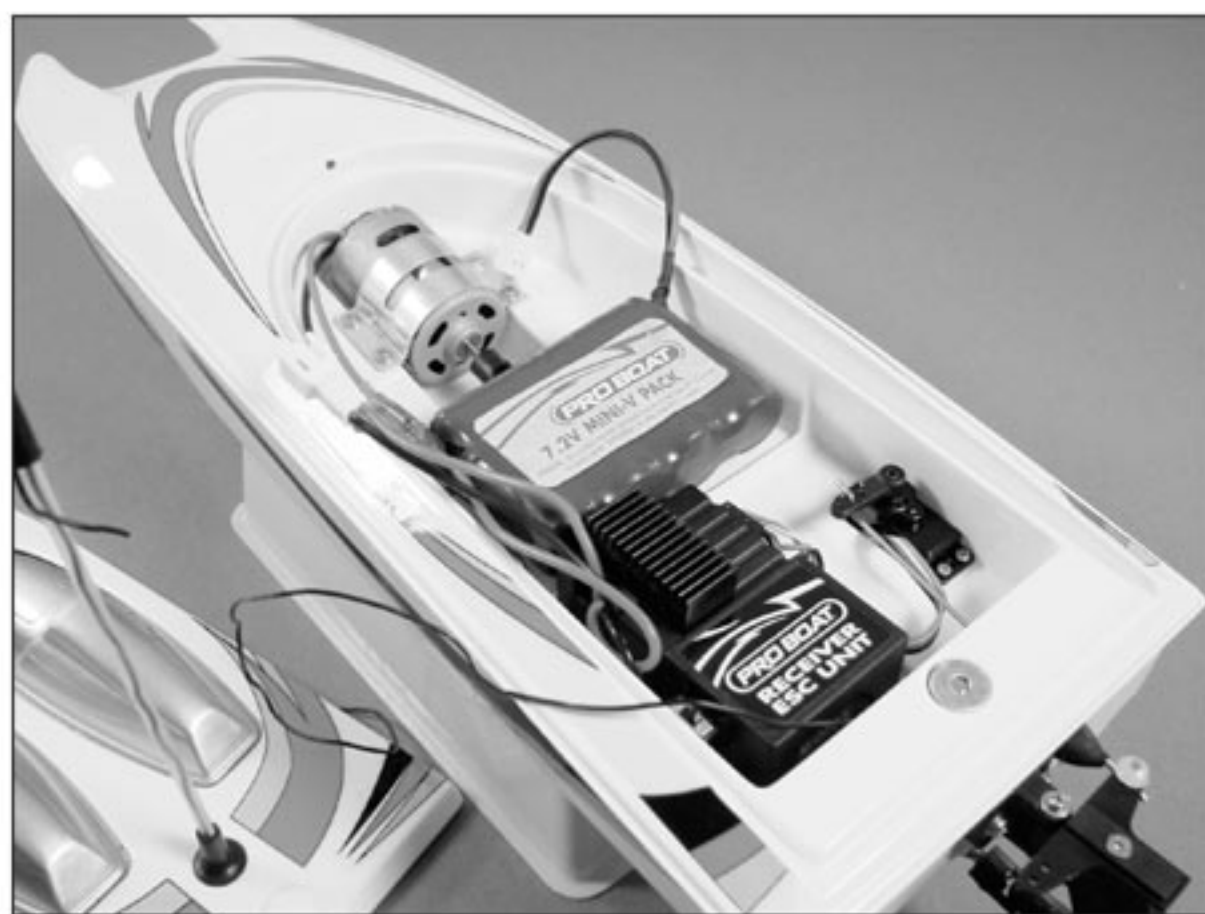

Confirm the switch has been set to the "OFF" position at this time.

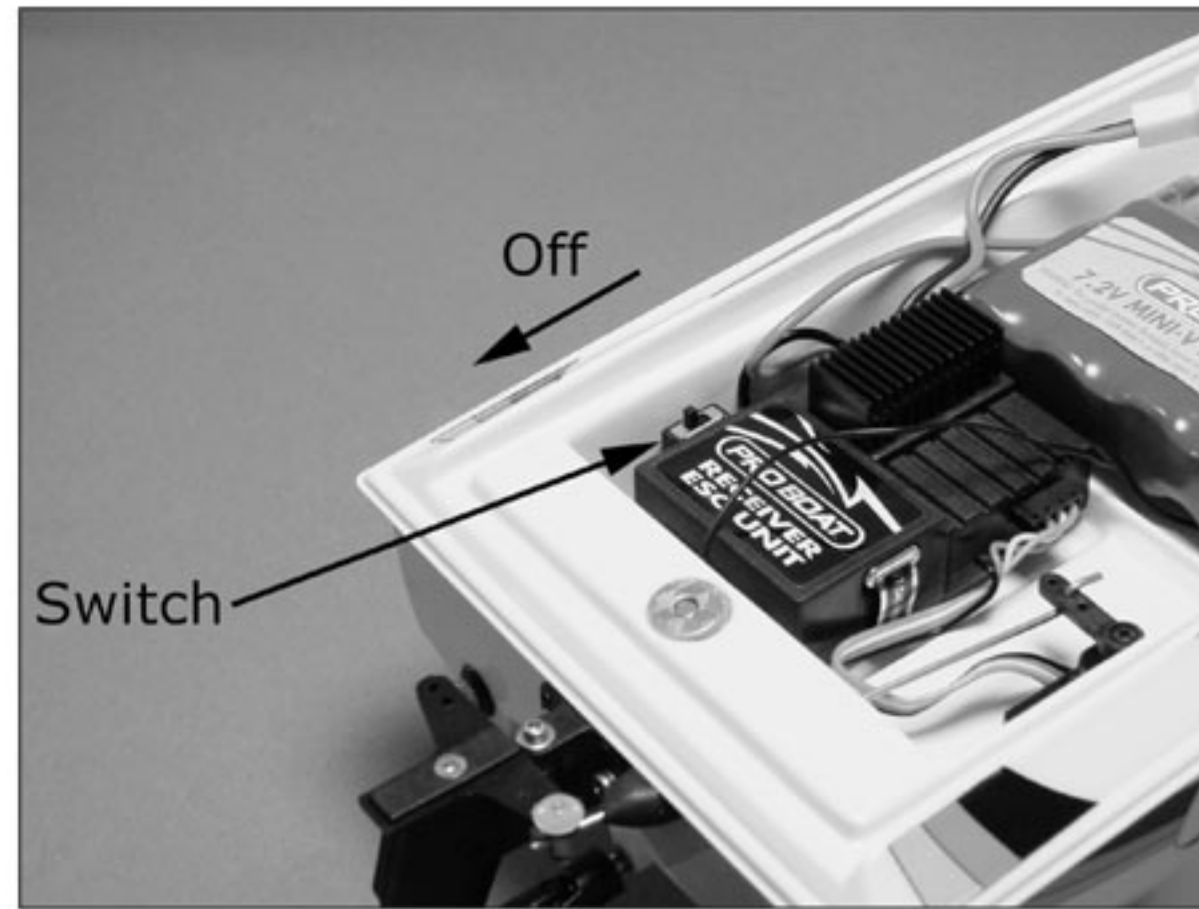

Plug the battery pack into the ESC.



Checking the Radio System

Check to make sure the propeller is free from any objects. The first time you turn on your Mini-C the motor may start, and any objects near the propeller, or even the propeller, may become damaged if the propeller begins rotating.

Always turn on the transmitter first by sliding the switch on the rear of the transmitter upwards. The small red and green lights on the side of the transmitter should both light up. If not, you need to check for low or incorrectly installed batteries.

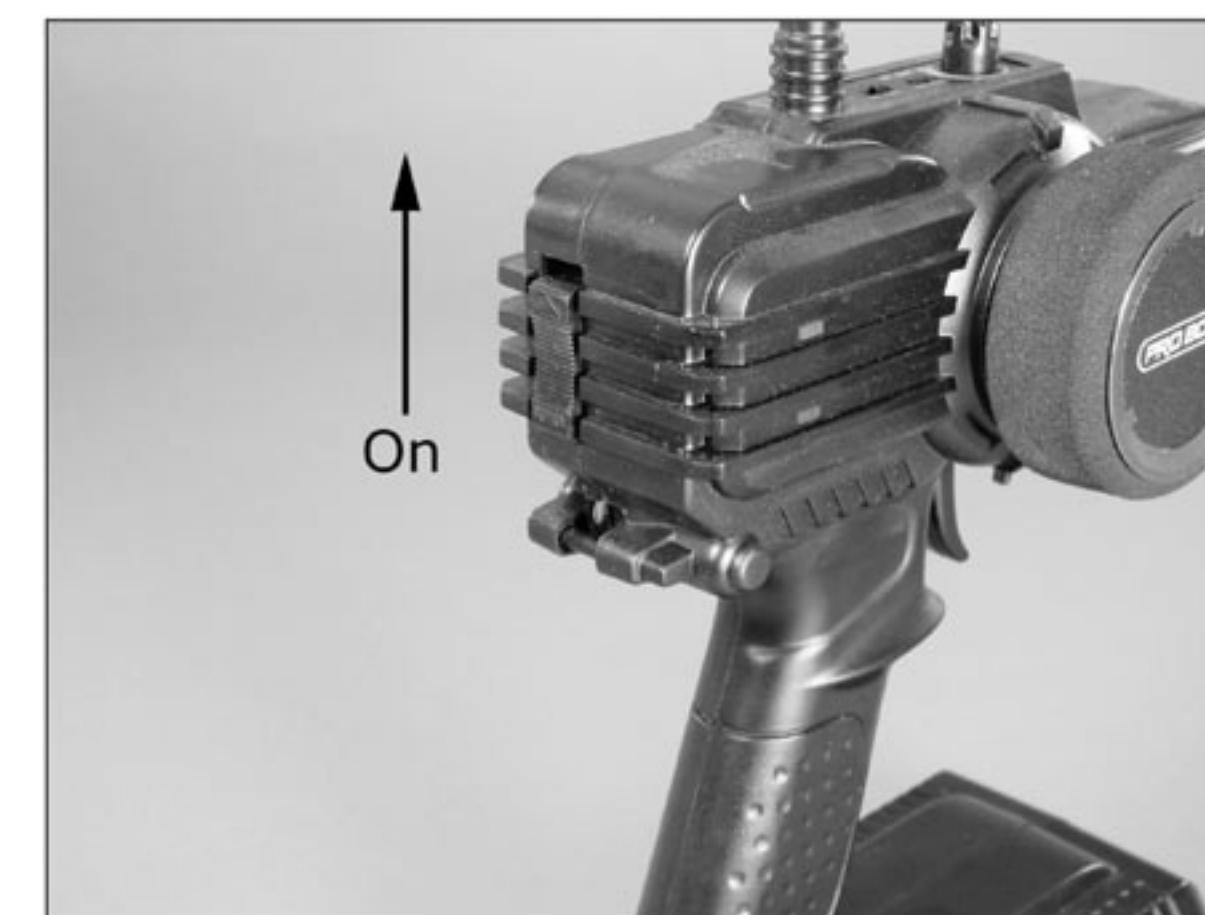

Checking the Throttle Operation

Once the transmitter has been turned on, turn on the Mini-C by sliding the switch on the speed controller to the "On" position.

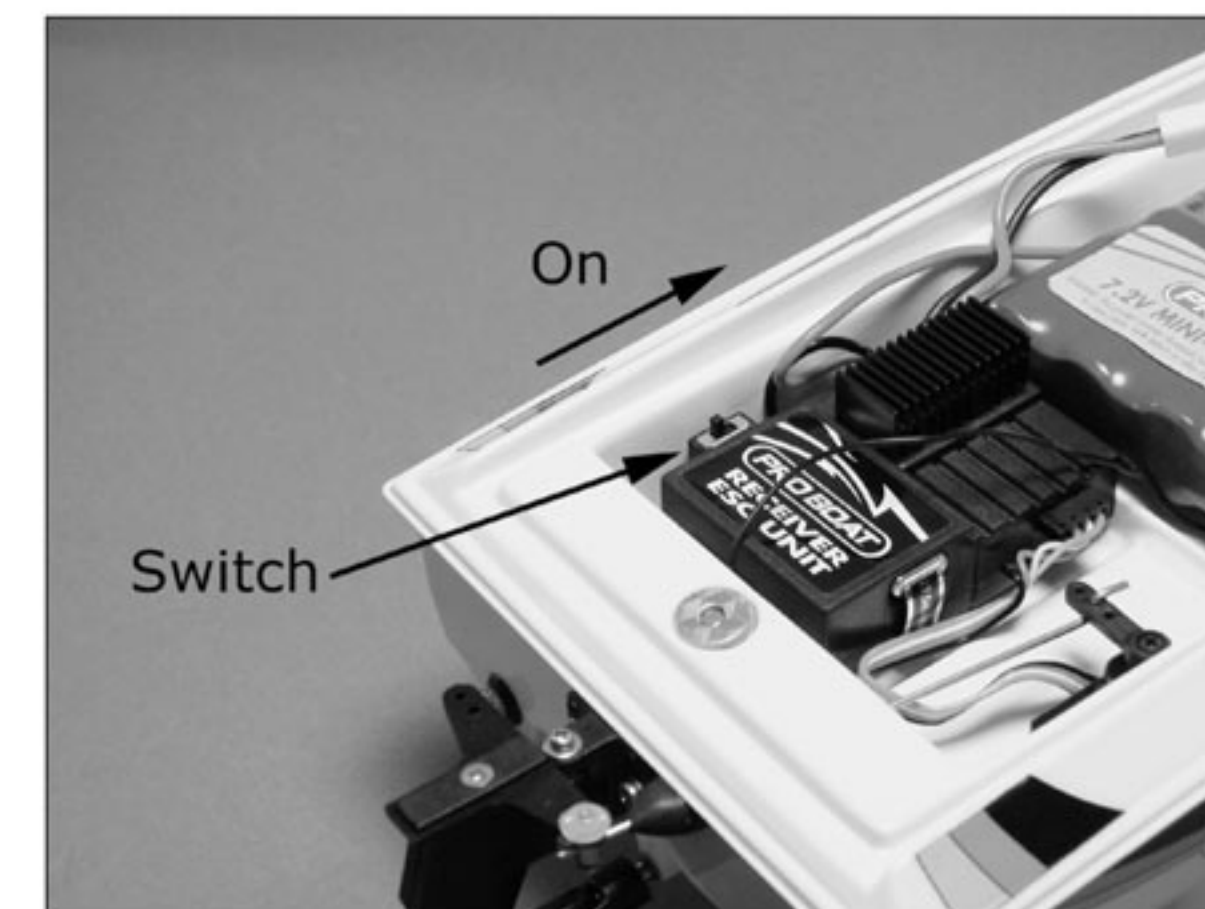

If the propeller spins, adjust the Throttle Trim (Th. Trim) knob located to the lower right of the steering wheel until it stops.



Give a small amount of throttle input by pulling the throttle trigger back to ensure the motor is working.



To test reverse speed operation, wait for the model to stop then push the trigger forward. Once everything is functioning correctly, you are ready to check the operation of the steering.

Checking the Radio System

Checking the Steering Operation

With your Mini-C and transmitter on, rotate the steering wheel on the transmitter clockwise to make the rudder/propeller move to the right to incur a right turn. The rudder control arm should also move toward the front of the boat when right input is given. Conversely, when left input is given, the control arm should move toward the back of the boat.

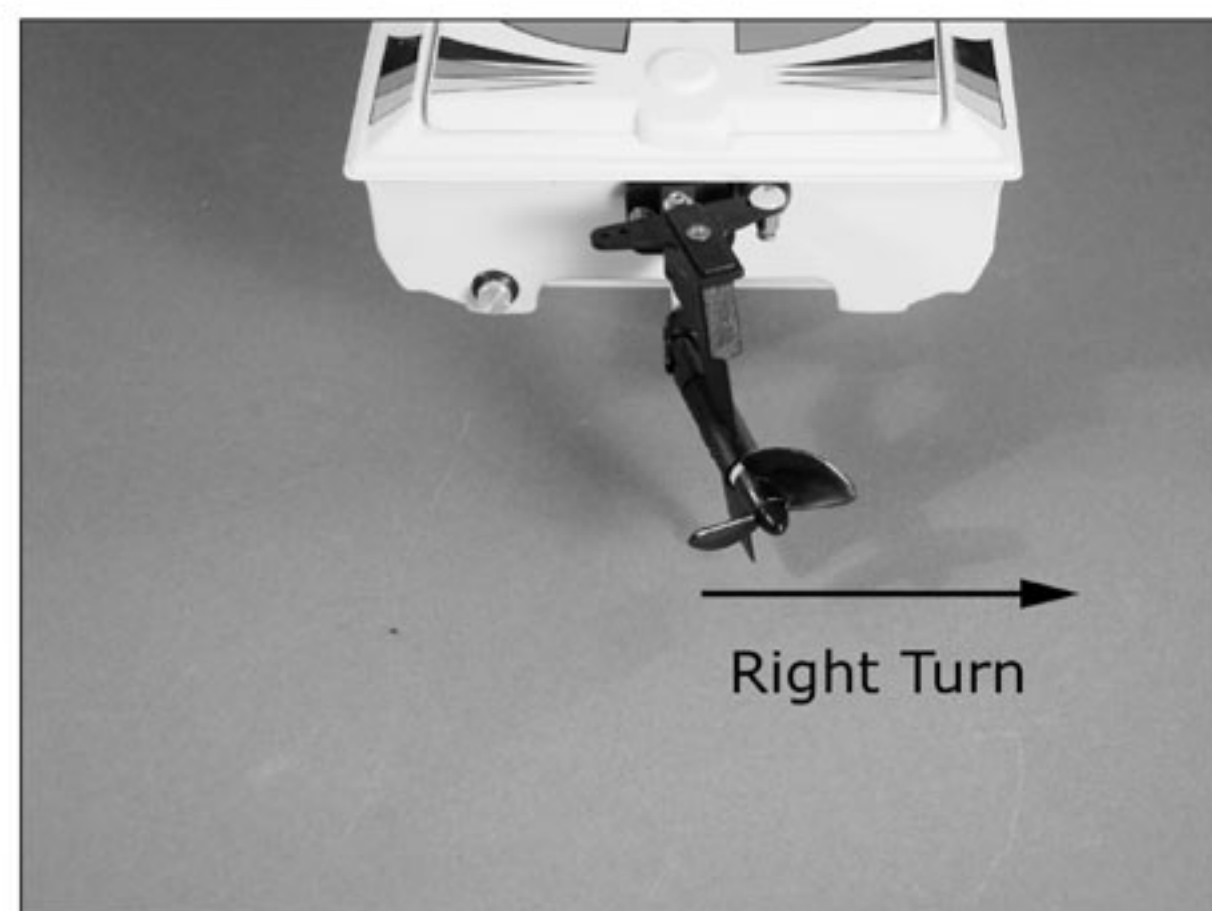

It may be necessary to adjust the rudder trim knob so the rudder is centered prior to operation. Use the Steering Trim (St. Trim) knob to center the rudder prior to operation. You may also need to fine-tune the steering trim to make sure the boat runs straight during operation. This can only be accomplished when operating the boat in the water and is detailed in a following section.



After you have completed checking your radio system, turn the Mini-C receiver off FIRST by sliding the switch to the "OFF" position. After the model has been turned off, turn off the transmitter.

If you find the steering or throttle operates backwards as described, you may need to switch the servo reversing as shown.

Note: If you are transporting your Mini-C, make sure you disconnect the battery from the speed controller and then turn your radio off until you are ready to run the boat. Once ready, simply plug the battery into the speed controller, turn the radio on and make sure that the boat is in neutral.

Testing Your Boat in the Water

Make sure the radio is "ON" and the battery is plugged into the speed controller. Test the radio system for proper operation and then carefully place the boat in the water. Pilot the boat at slow speeds, staying close to the shoreline to ensure you have good control and that the boat is functioning correctly. Be certain to avoid all objects in the water at all times.

Once you feel comfortable with the control of your boat, it is safe to go further away from the shoreline and at faster speeds. When you notice the boat beginning to lose speed, bring the boat back to shore. It will be necessary to allow the electronic components to cool down and to replace or recharge the battery before heading out again.

Handling Adjustments

When going forward, the model should move in a straight line. If not, adjust the steering trim so that it tracks in a straight line without having to turn the steering wheel.

Operate your Mini-C in low-wake conditions to avoid having problems with the boat overturning. If the conditions are questionable, adjust the prop strut down a bit to reduce the likelihood of having the boat overturn.

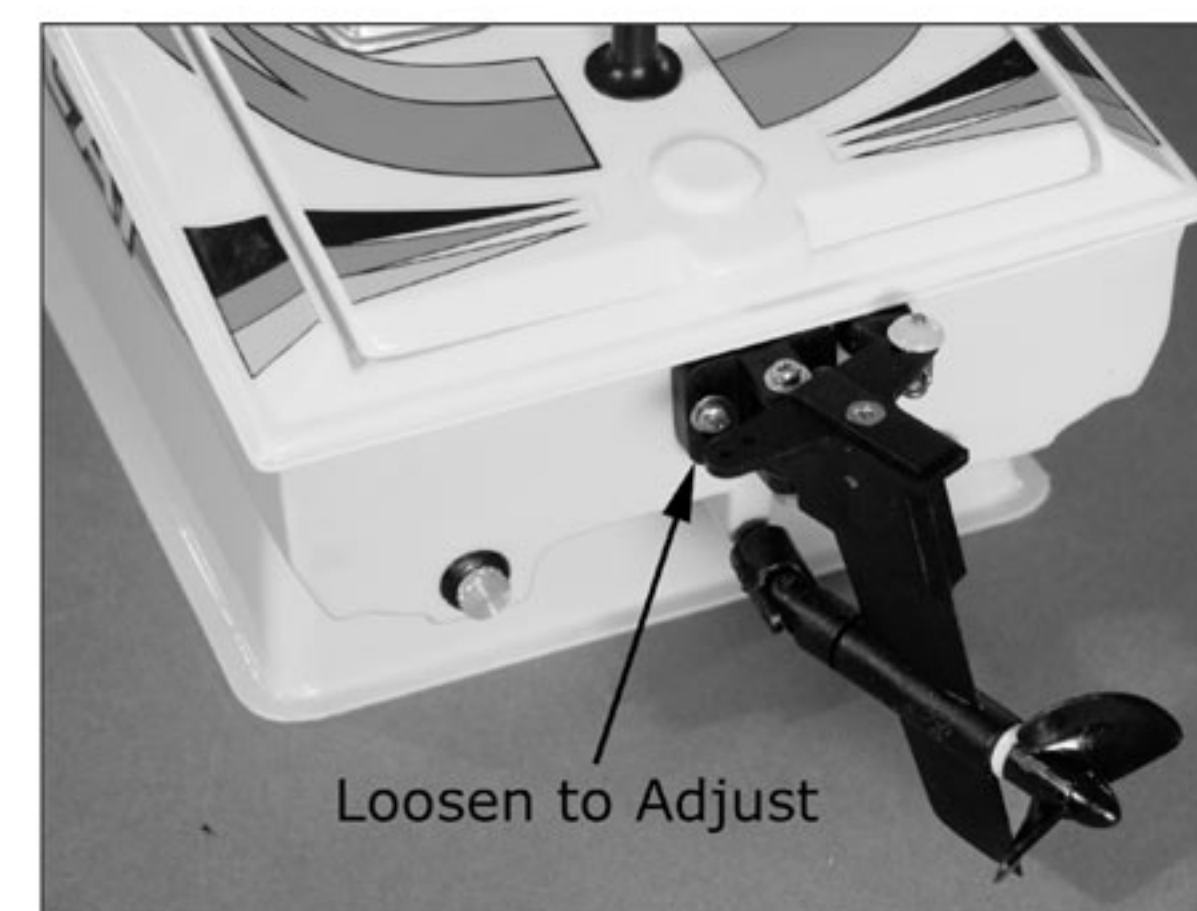

It may also be necessary to adjust the "Dual Rate" dial down at the transmitter to reduce rudder travel in rough water conditions or if the boat tends to over-steer (hook) during sharp turns.

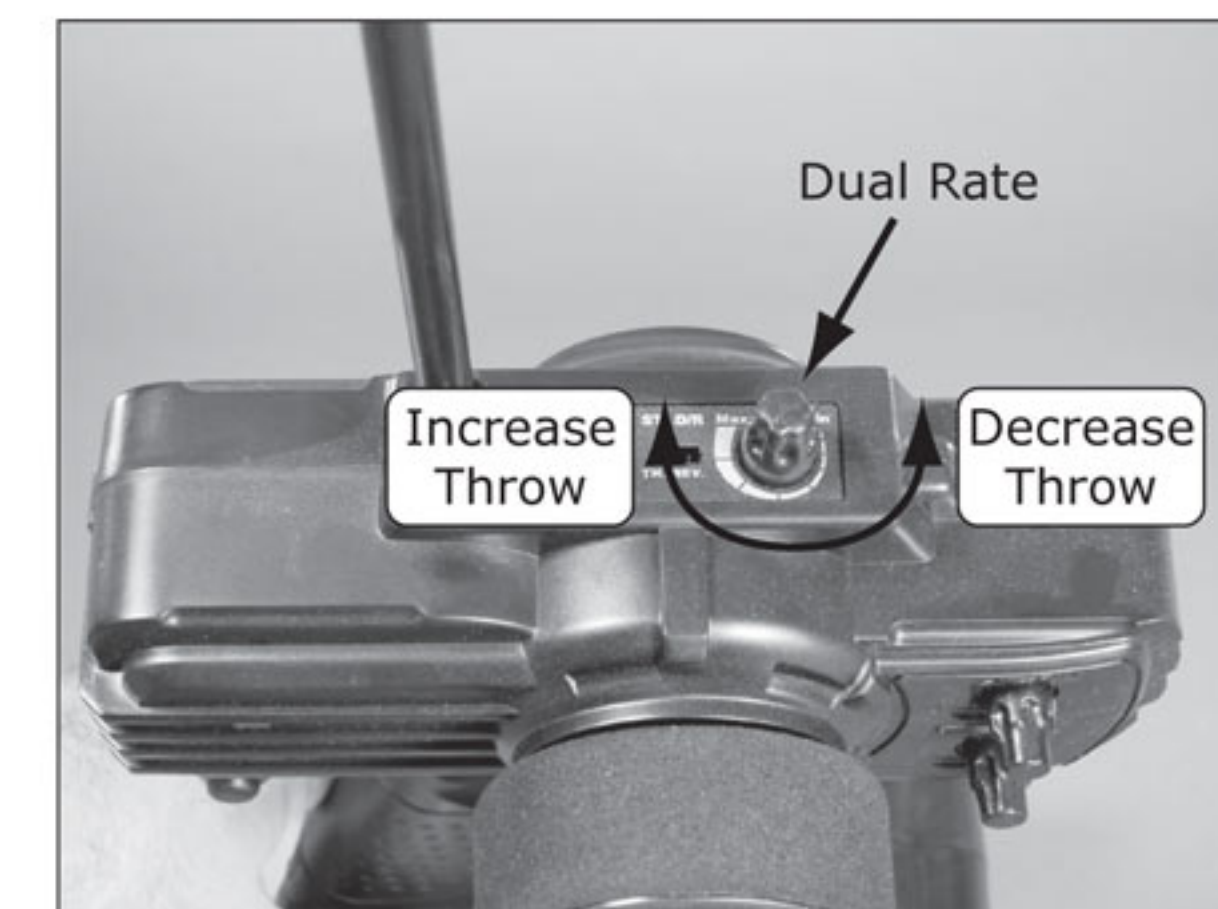

Note: Catamaran hulls inherently have a slight amount of cavitation (propeller does not immediately gain traction) when the propeller is positioned to allow for top speed. The throttle should be increased slowly to allow the boat to reach operating speeds before full throttle input is given. The drive system can be adjusted to produce faster initial acceleration but top speeds will be reduced.

Maintenance

Before and at the end of each run, make sure all screws are tight and the propeller is free from any entanglement. At the end of each run, be sure to remove any debris from the rudder and/or propeller and rinse the hull of your boat as well.

Lubricating the Drive Shaft

The drive shaft should be lubricated immediately after running in salt water, after every 3-4 hours of use and at the end of each boating season prior to storage to ensure proper operation of your boat. The following illustrates removing and lubricating the drive shaft.

Loosen the 1.5mm setscrew connecting the drive shaft to the motor coupler.



Loosen the 1.5mm setscrew connecting the universal joint to the drive shaft.

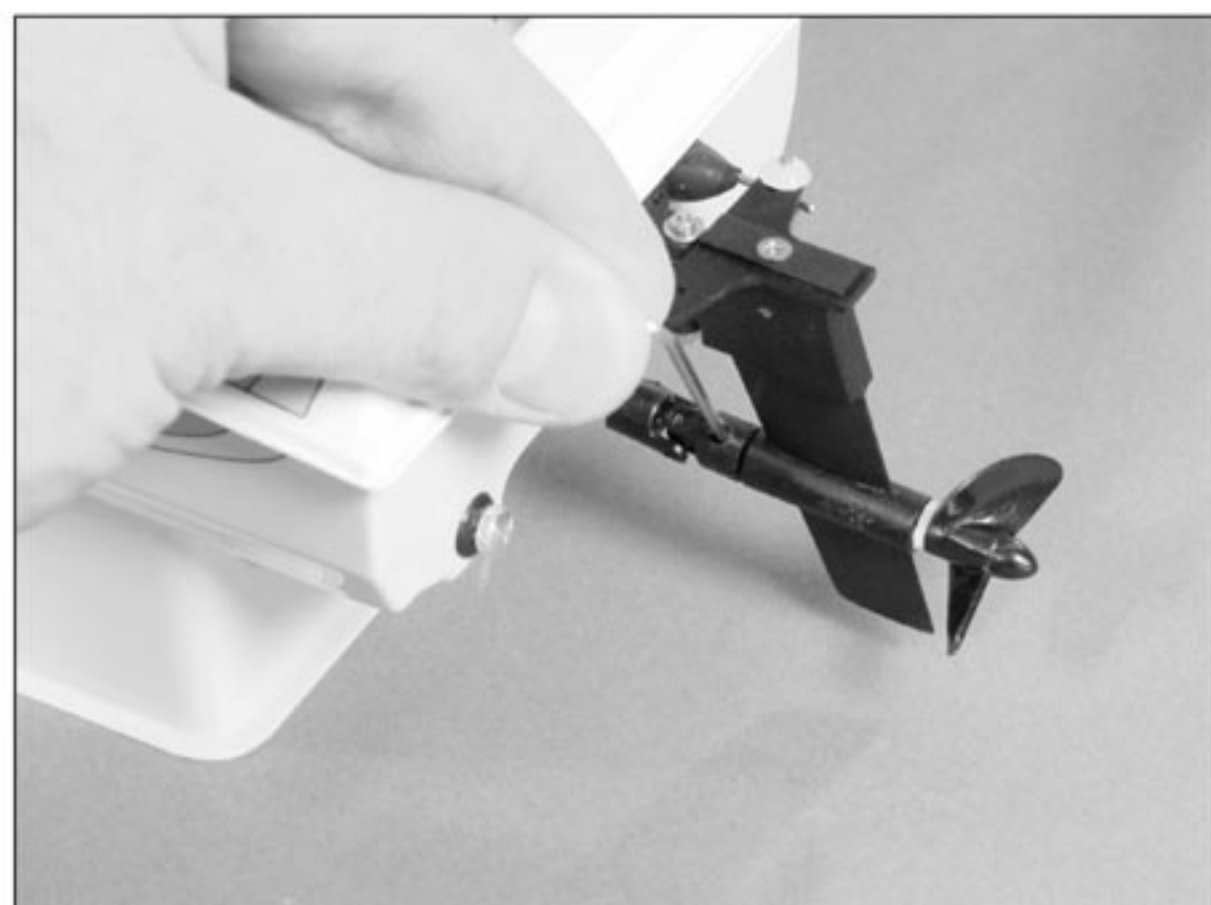

Carefully slide the propeller shaft from the rudder assembly and set aside.

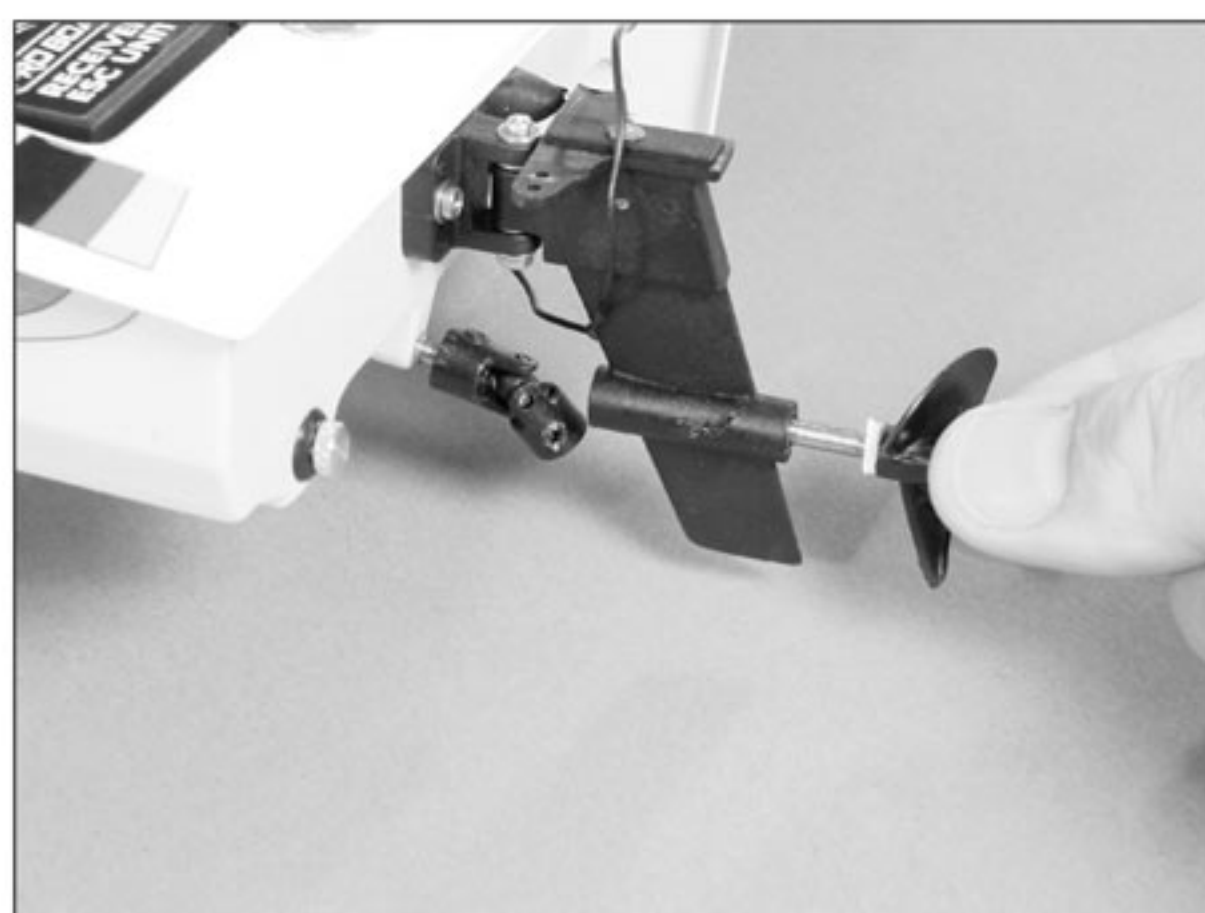

Move the rudder assembly to either the full left turn or full right turn and slide the drive shaft out of the stuffing box.

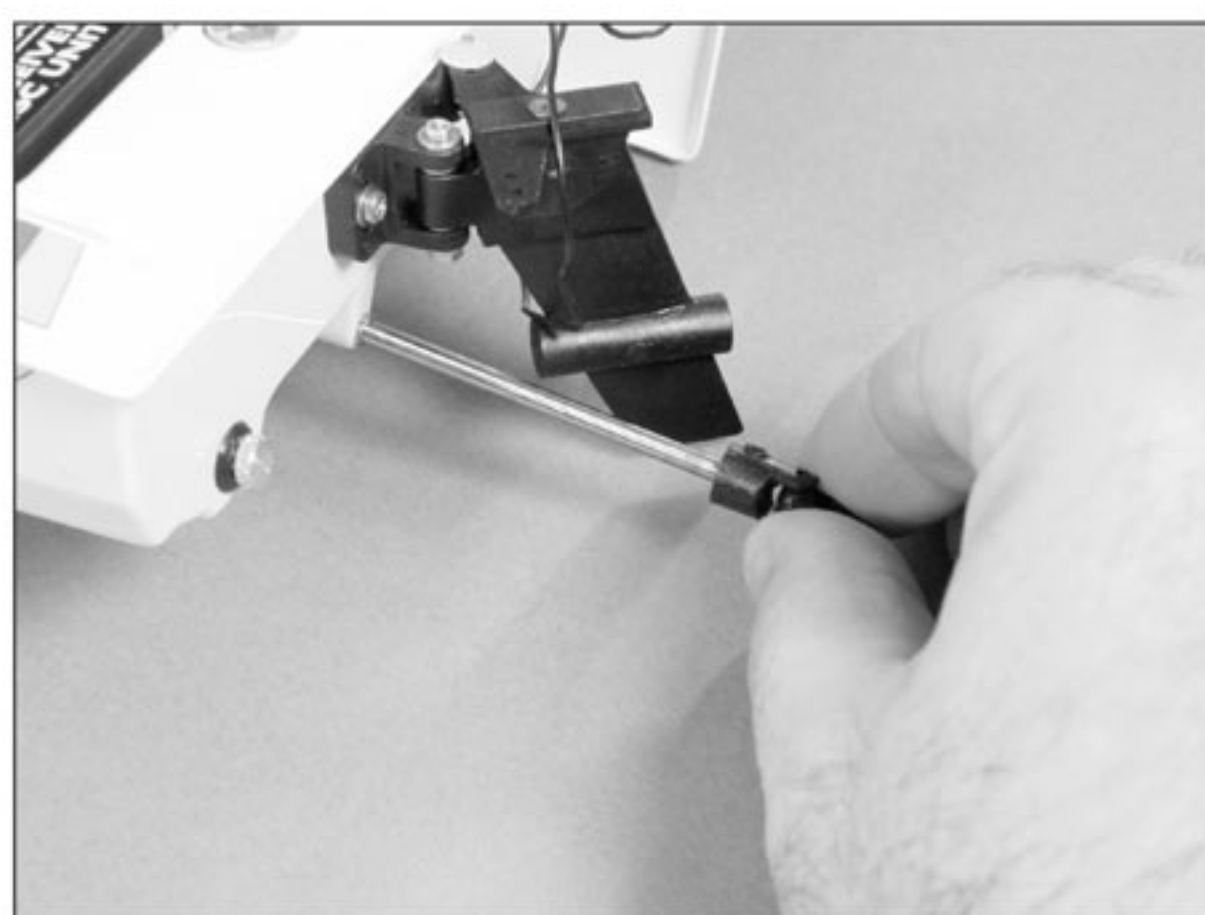

Lubricate the drive shaft with PRB0100 Water-Proof Marine Grease (see your local hobby shop).



Maintenance

Lubricate the propeller shaft with PRB0100 Water-Proof Marine Grease (see your local hobby shop).



Reinstall the drive shaft and propeller shaft in reverse order. Be sure to reinstall the nylon washer between the propeller and rudder assembly for the propeller shaft.

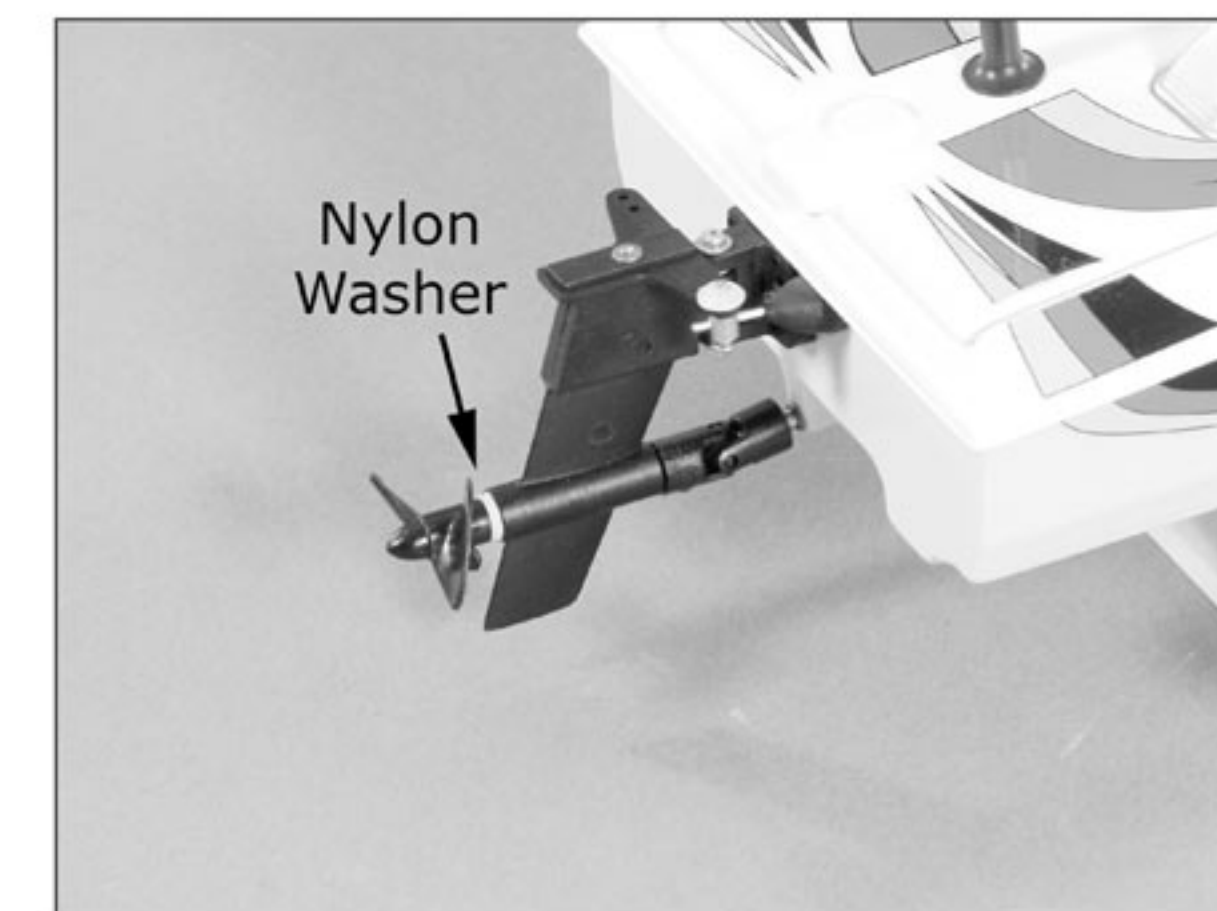

Note: Running the Mini-C RTR in salt water could cause some parts to corrode. If you run the boat in salt water, rinse it thoroughly in fresh water after each use and lubricate the drive system.

Replacement Parts

If you have any questions concerning the setup or running of your Mini-C, please call the Horizon Service Center toll-free at (877) 504-0233.

PRB3703	Hull (White) Mini-C
PRB3704	Hull (Red) Mini-C
PRB3705	Hull (Yellow) Mini-C
PRB3706	Hatch: Mini-C
PRB3707	Boat Stand: Mini-C
PRB3708	Decal: Mini-C
PRB3315	Antenna Mount: Mini-C
PRB3006	Outdrive Unit Complete
PRB3007	Driveshaft
PRB3008	Universal Joint Set (2)
PRB3009	Motor Mount
PRB3010	Motor
PRB3011	Steering Rod w/Links
PRB2228	Rubber Boot
PRB3013	Prop w/Shaft and Bushings
PRB3014	Steering Servo Arm
PRB1200	7.2V Battery w/110V AC Charger
PRB1202	7.2V Battery Only
LOSB1084	Transmitter
LOSB1091	Servo
LOSB1092	Servo Gear Set
LOSB1087	Receiver/ESC Unit

Identification of Components

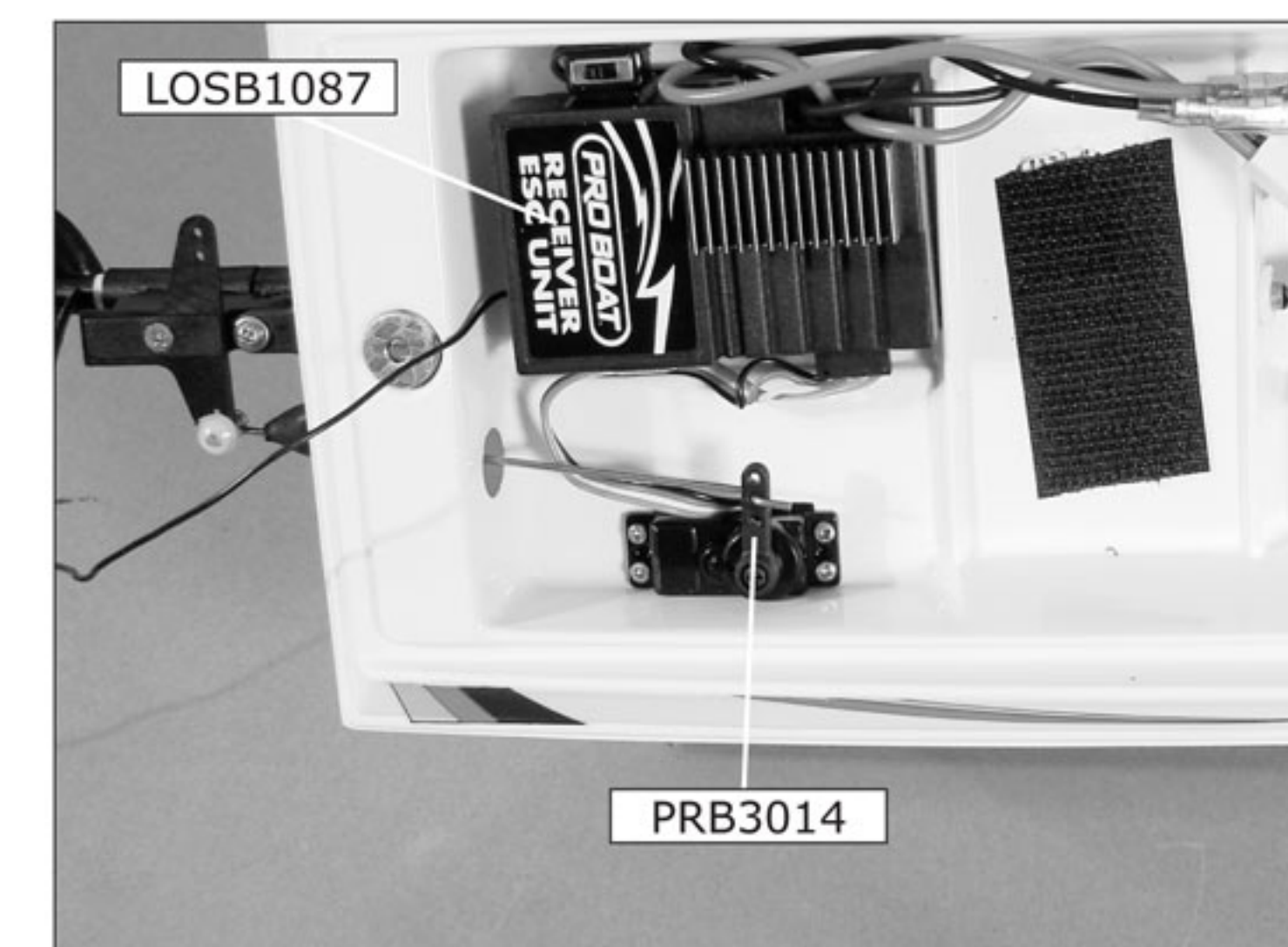
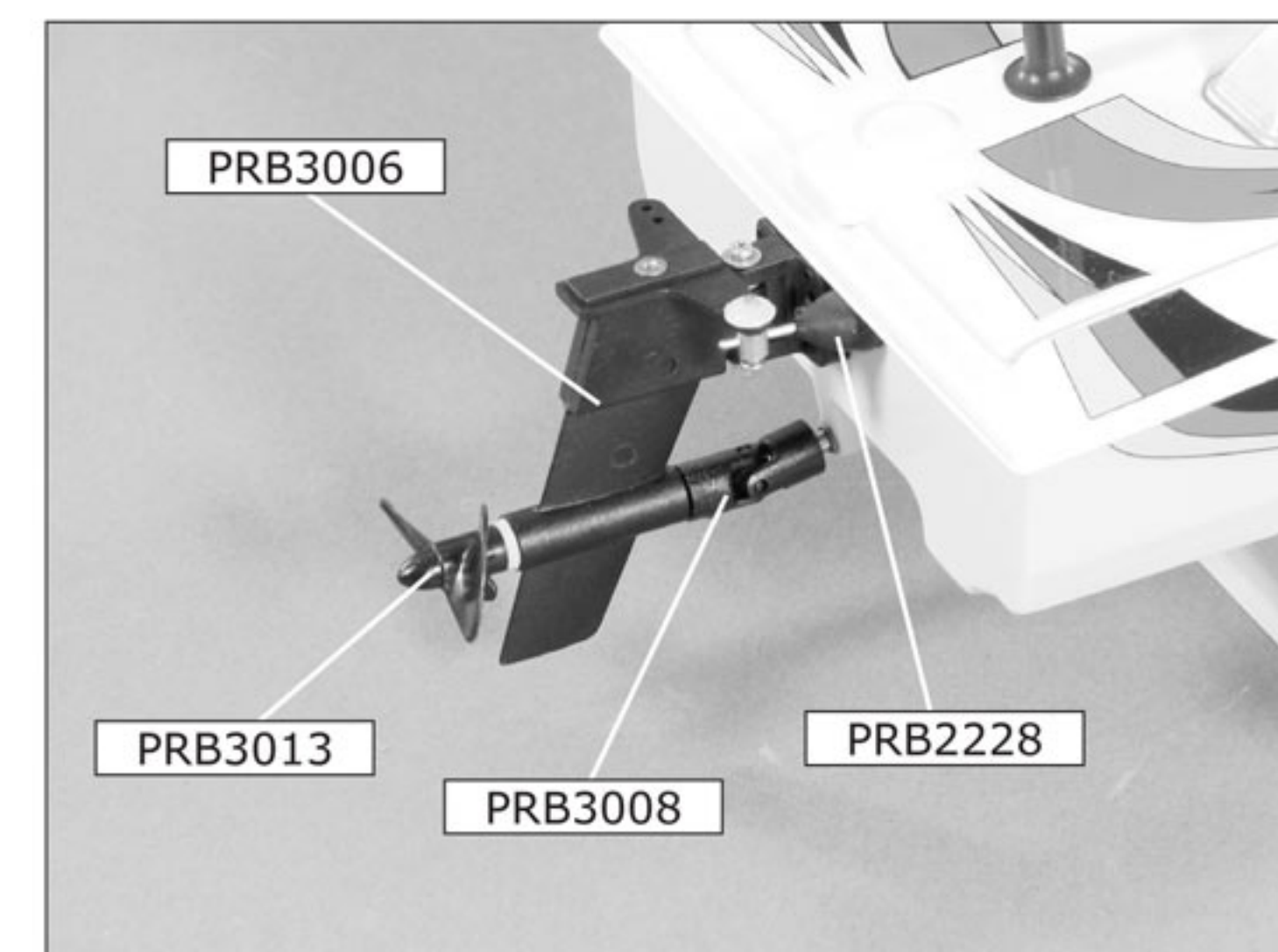
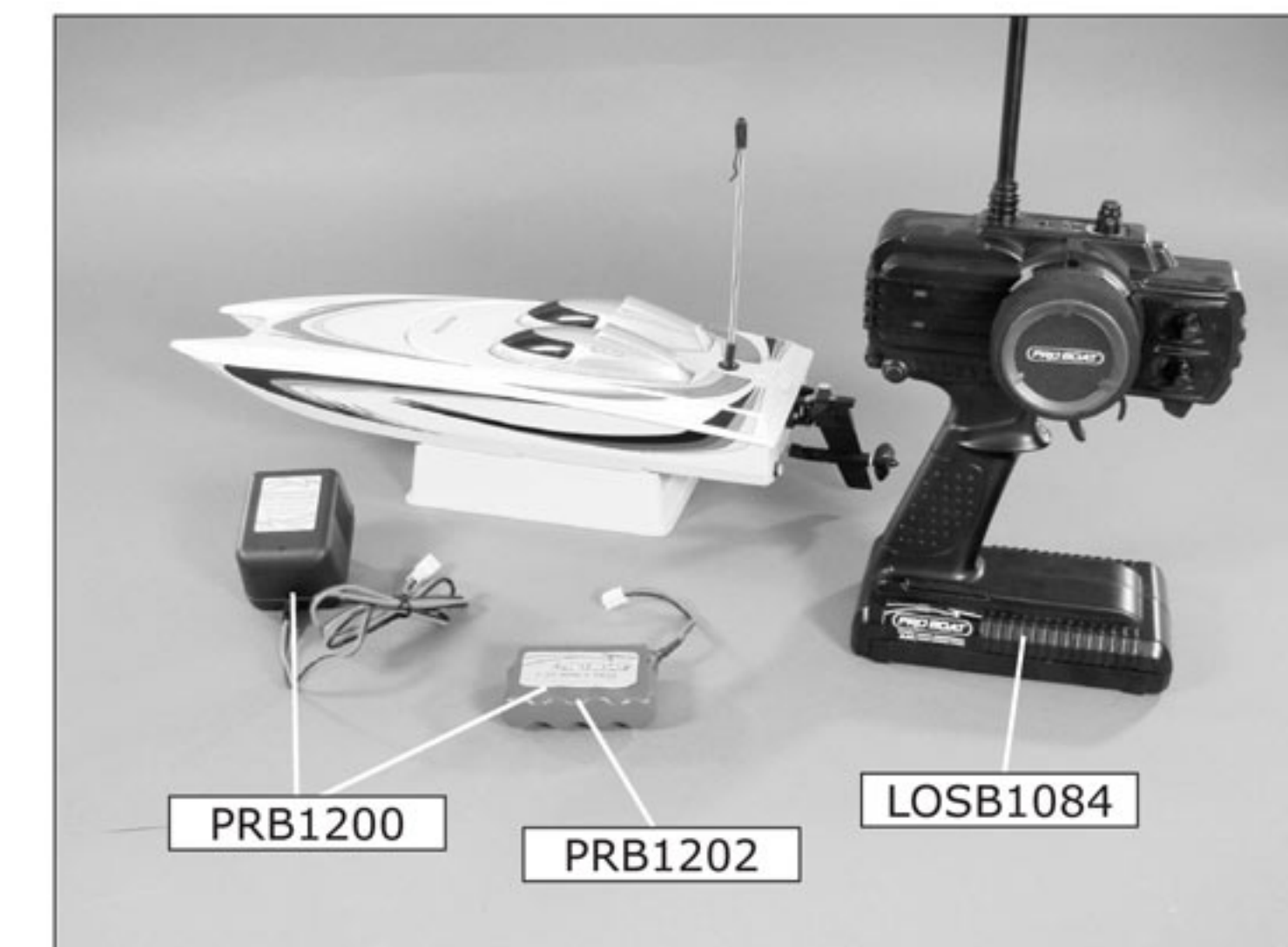
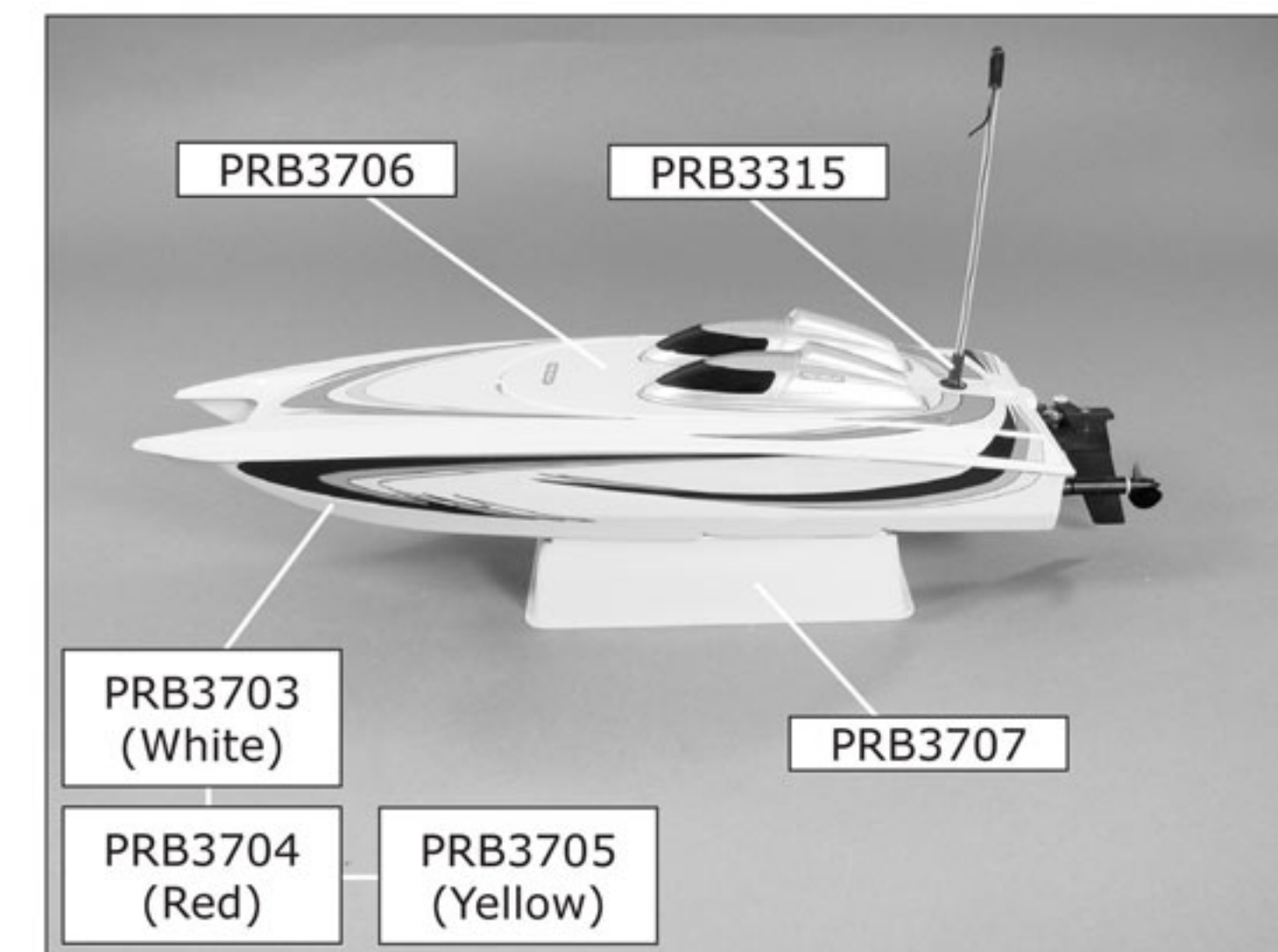
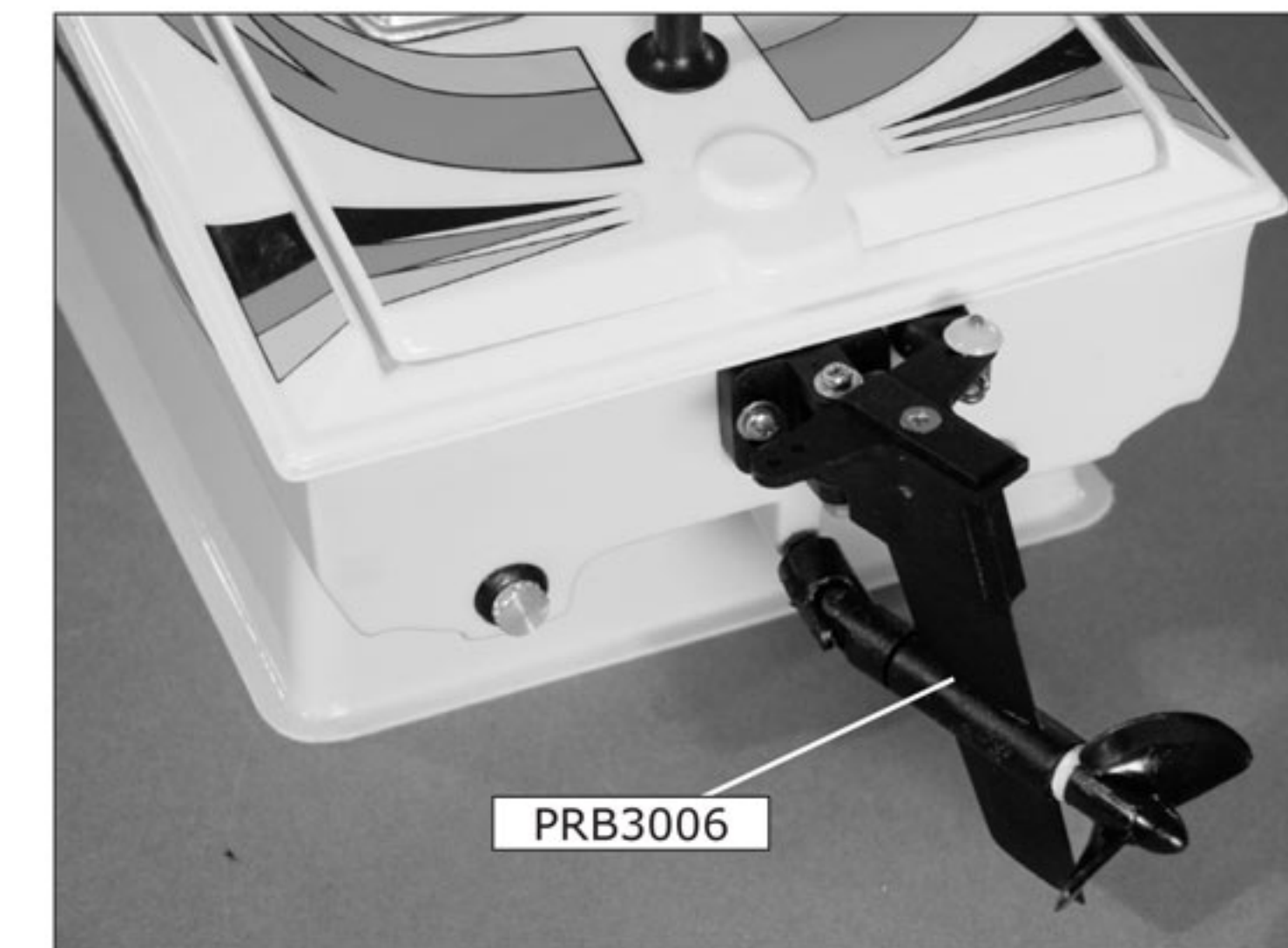
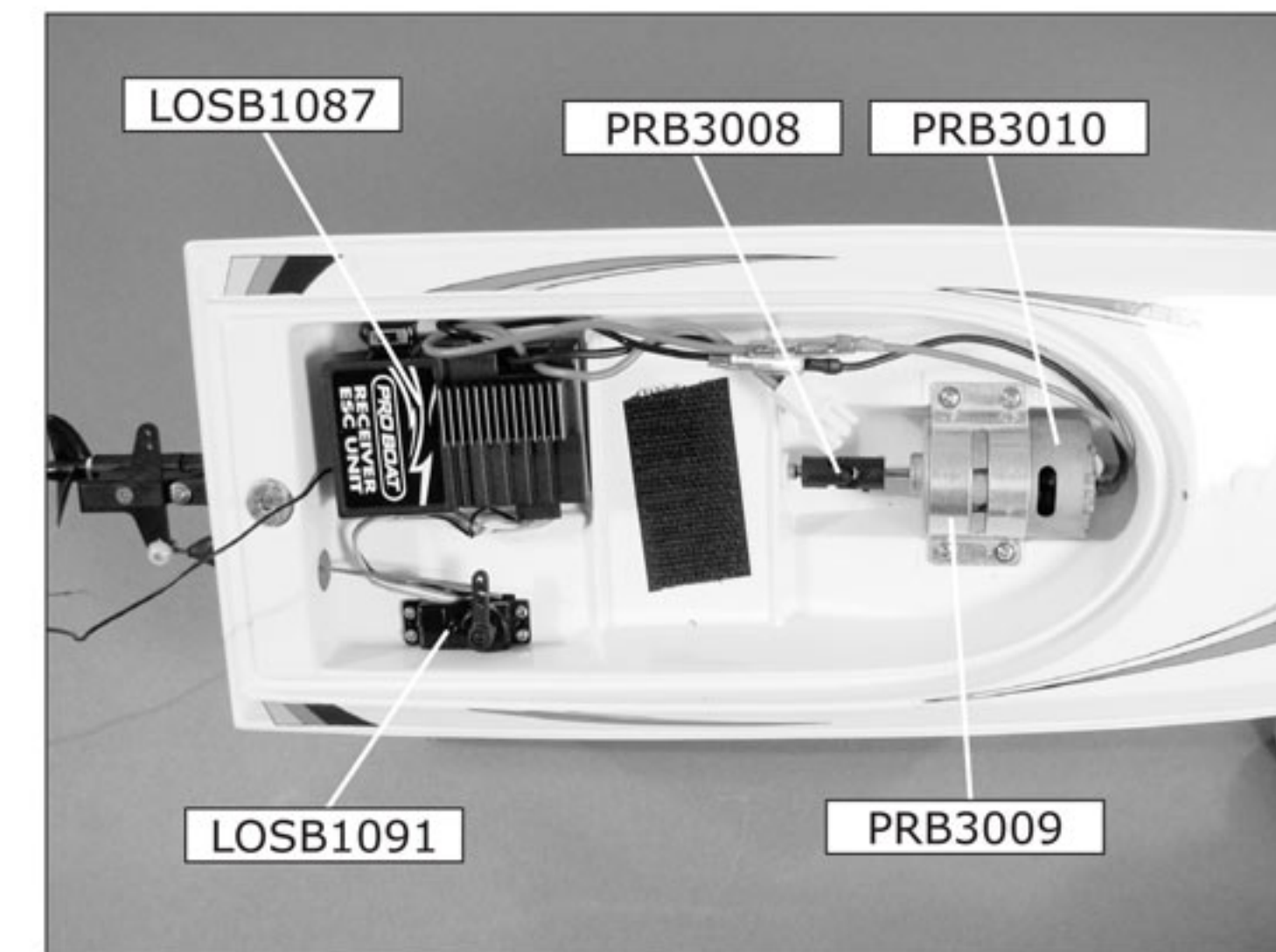

Instructions for Disposal of WEEE by Users in the European Union

This product must not be disposed of with other waste. Instead, it is the user's responsibility to dispose of their waste equipment by handing it over to a designated collection point for the recycling of waste electrical and electronic equipment. The separate collection and recycling of your waste equipment at the time of disposal will help to conserve natural resources and ensure that it is recycled in a manner that protects human

health and the environment. For more information about where you can drop off your waste equipment for recycling, please contact your local city office, your household waste disposal service or where you purchased the product.



Warranty Information

Warranty Period

Horizon Hobby, Inc., (Horizon) warrants that the Products purchased (the "Product") will be free from defects in materials and workmanship at the date of purchase by the Purchaser.

Limited Warranty

(a) This warranty is limited to the original Purchaser ("Purchaser") and is not transferable. REPAIR OR REPLACEMENT AS PROVIDED UNDER THIS WARRANTY IS THE EXCLUSIVE REMEDY OF THE PURCHASER. This warranty covers only those Products purchased from an authorized Horizon dealer. Third party transactions are not covered by this warranty. Proof of purchase is required for warranty claims. Further, Horizon reserves the right to change or modify this warranty without notice and disclaims all other warranties, express or implied.

(b) Limitations- HORIZON MAKES NO WARRANTY OR REPRESENTATION, EXPRESS OR IMPLIED, ABOUT NON-INFRINGEMENT, MERCHANTABILITY OR

FITNESS FOR A PARTICULAR PURPOSE OF THE PRODUCT. THE PURCHASER ACKNOWLEDGES THAT THEY ALONE HAVE DETERMINED THAT THE PRODUCT WILL SUITABLY MEET THE REQUIREMENTS OF THE PURCHASER'S INTENDED USE.

(c) Purchaser Remedy- Horizon's sole obligation hereunder shall be that Horizon will, at its option, (i) repair or (ii) replace, any Product determined by Horizon to be defective. In the event of a defect, these are the Purchaser's exclusive remedies. Horizon reserves the right to inspect any and all equipment involved in a warranty claim. Repair or replacement decisions are at the sole discretion of Horizon. This warranty does not cover cosmetic damage or damage due to acts of God, accident, misuse, abuse, negligence, commercial use, or modification of or to any part of the Product. This warranty does not cover damage due to improper installation, operation, maintenance, or attempted repair by anyone other than Horizon. Return of any goods by Purchaser must be approved in writing by Horizon before shipment.

Warranty Information

Damage Limits

HORIZON SHALL NOT BE LIABLE FOR SPECIAL, INDIRECT OR CONSEQUENTIAL DAMAGES, LOSS OF PROFITS OR PRODUCTION OR COMMERCIAL LOSS IN ANY WAY CONNECTED WITH THE PRODUCT, WHETHER SUCH CLAIM IS BASED IN CONTRACT, WARRANTY, NEGLIGENCE, OR STRICT LIABILITY. Further, in no event shall the liability of Horizon exceed the individual price of the Product on which liability is asserted. As Horizon has no control over use, setup, final assembly, modification or misuse, no liability shall be assumed nor accepted for any resulting damage or injury. By the act of use, setup or assembly, the user accepts all resulting liability.

If you as the Purchaser or user are not prepared to accept the liability associated with the use of this Product, you are advised to return this Product immediately in new and unused condition to the place of purchase.

Law: These Terms are governed by Illinois law (without regard to conflict of law principals).

Safety Precautions

This is a sophisticated hobby Product and not a toy. It must be operated with caution and common sense and requires some basic mechanical ability. Failure to operate this Product in a safe and responsible manner could result in injury or damage to the Product or other property. This Product is not intended for use by children without direct adult supervision.

The Product manual contains instructions for safety, operation and maintenance. It is essential to read and follow all the instructions and warnings in the manual, prior to assembly, setup or use, in order to operate correctly and avoid damage or injury.

Questions, Assistance, and Repairs

Your local hobby store and/or place of purchase cannot provide warranty support or repair. Once assembly, setup or use of the Product has been started, you must contact Horizon directly. This will enable Horizon to better answer your questions and service you in the event that you may need any assistance.

For questions or assistance, please direct your email to productsupport@horizonhobby.com, or call 877.504.0233 toll-free to speak to a service technician.

Inspection or Repairs

If this Product needs to be inspected or repaired, please call for a Return Merchandise Authorization (RMA). Pack the Product securely using a shipping carton. Please note that original boxes may be included, but are not designed to withstand the rigors of shipping without additional protection. Ship via a carrier that provides tracking and insurance for lost or damaged parcels, as Horizon is not responsible for merchandise until it arrives and is accepted at our facility. A Service Repair Request is available at www.horizonhobby.com on the "Support" tab.

If you do not have internet access, please include a letter with your complete name, street address, email address and phone number where you can be reached during business days, your RMA number, a list of the included items, method of payment for any non-warranty expenses and a brief summary of the problem. Your original sales receipt must also be included for warranty consideration. Be sure your name, address, and RMA number are clearly written on the outside of the shipping carton.

Warranty Inspection and Repairs

To receive warranty service, you must include your original sales receipt verifying the proof-of-purchase date. Provided warranty conditions have been met, your Product will be repaired or replaced free of charge.

Repair or replacement decisions are at the sole discretion of Horizon Hobby.

Non-Warranty Repairs

Should your repair not be covered by warranty the repair will be completed and payment will be required without notification or estimate of the expense unless the expense exceeds 50% of the retail purchase cost. By submitting the item for repair you are agreeing to payment of the repair without notification. Repair estimates are available upon request. You must include this request with your repair. Non-warranty repair estimates will be billed a minimum of ½ hour of labor. In addition you will be billed for return freight. Please advise us of your preferred method of payment. Horizon accepts money orders and cashiers checks, as well as Visa, MasterCard, American Express, and Discover cards. If you choose to pay by credit card, please include your credit card number and expiration date. Any repair left unpaid or unclaimed after 90 days will be considered abandoned and will be disposed of accordingly. Please note: non-warranty repair is only available on electronics and model engines.

Electronics and engines requiring inspection or repair should be shipped to the following address:

Horizon Service Center
4105 Fieldstone Road
Champaign, Illinois 61822

All other Products requiring warranty inspection or repair should be shipped to the following address:

Horizon Product Support
4105 Fieldstone Road
Champaign, Illinois 61822

Please call 877-504-0233 with any questions or concerns regarding this product or warranty.

Safety, Precautions, and Warnings

As the user of this product, you are solely responsible for operating it in a manner that does not endanger yourself and others or result in damage to the product or the property of others.

Carefully follow the directions and warnings for this and any optional support equipment (chargers, rechargeable battery packs, etc.) that you use.

This model is controlled by a radio signal that is subject to interference from many sources outside your control. This interference can cause momentary loss of control so it is necessary to always keep a safe distance in all directions around your model, as this margin will help to avoid collisions or injury.

- Always operate your model in an open area away from people.
- Avoid operating your model where injury or damage can occur.
- Never operate the model out in populated areas for any reason.
- Never operate your model with low transmitter batteries.
- Carefully follow the directions and warnings for this and any optional support equipment (chargers, rechargeable battery packs, etc.) that you use.
- Keep all chemicals, small parts and anything electrical out of the reach of children.
- Moisture causes damage to electronics. Avoid prolonged water exposure to all equipment not specifically designed and protected for this purpose.



© 2007, Horizon Hobby,
Inc.
4105 Fieldstone Road
Champaign, Illinois 61822
(877) 504-0233
www.horizonhobby.com