



# F-27C STRYKER™

## Instruction Manual



PKZ4206



ParkZone® products are distributed exclusively by  
Horizon Hobby, Inc.  
4105 Fieldstone Road  
Champaign, IL 61822  
© 2006 Horizon Hobby, Inc.  
www.parkzone.com



**Charge-and-Fly™ Park Flyer**

Wingspan: 37 in (940mm)  
Length: 27 in (690mm)  
Weight: 22 oz (620 g)  
Motor: 6-pole brushless direct-drive, 1880Kv  
Speed Control: E-flite 25A brushless ESC

FM Radio System: 4 channels on 72MHz (3 channels utilized)  
Battery: 3-cell 11.1V 2200mAh Li-Po  
Charger: 2- to 3-cell variable rate DC balancing Li-Po charger  
Prop: 6 x 4

# F-27C Stryker Instruction Manual

Congratulations on your purchase of the ParkZone® F-27C Stryker™ Charge and Fly™ park flyer. Your F-27C has come with everything needed to get you in the air—all in one box! You will only need to attach the vertical fins, attach the nose, and charge the battery pack prior to flight.

Everyone at ParkZone is committed to giving you the most enjoyable flight experience you can have. In order to ensure a safe and successful flight, we ask that you do not fly until you have read these instructions thoroughly.

**Warning: We knocked this one out of the park!**

This is a high-performance airplane and is not a toy. The F-27C Stryker is capable of flying at speeds exceeding 80 miles per hour (129 kilometers per hour), so it is intended for highly experienced and expert radio control pilots only. We suggest that this airplane

is flown only at AMA approved flying sites. It travels much too fast to be flown in a “typical” park setting, even if this is where you usually fly your park flyers and even if there are many acres of space. Never fly where you may place anyone’s safety in jeopardy.

**Crash damage is not covered under any warranty.**

**Warning:**

Your F-27C Stryker comes with a 3S Li-Po battery pack that must be handled carefully at all times. Failure to follow the charging instructions properly could result in a fire! You must use an appropriate Li-Po charger to charge your Li-Po pack. The one supplied in the box with your F-27C Stryker will work very well.

## Step 1 TRANSMITTER

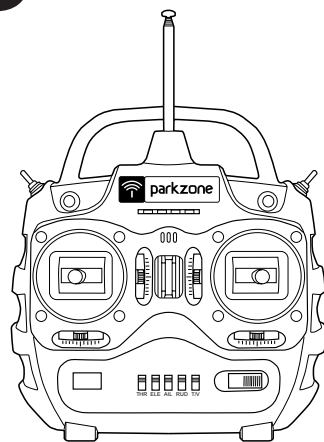

Your F-27C Stryker comes with a fully proportional, 4-Channel, 72MHz FM radio system. Your F-27C Stryker also features industry standard 3-wire servos, making the radio system usable in other small electric aircraft. The servo-reversing feature of the transmitter also makes the system ideal to use in another park flyer application. Always make certain the various switches are set correctly for your application prior to each flight.

**Transmitter Features:**

- Fully proportional, 4-Channel, 72MHz FM radio system
- Dual rate switch (high and low rates)
- Proportional trim adjustment
- LED battery voltage regulators
- Neck strap holder
- Charge jack for use with optional rechargeable transmitter batteries
- Servo reversing option
- Comfortable ergonomic case design

The stock setup for all of the servo reversing switches on the transmitter is set for the following:

**Throttle:** Normal    **Elevator:** Normal    **Aileron:** Reverse  
**Rudder:** Either    **Mix:** Reverse

**The following statement applies only to the receiver that is sold in the USA:**

This device complies with part 15 of the FCC rules. Operation is subject to the following two conditions:

1. This device may not cause harmful interference; and
2. This device must accept any interference received, including interference that may cause undesirable operation.

Changes or modifications not expressly approved by the party responsible for compliance could void the user’s authority to operate the equipment.

**To Test the Transmitter:**

1. Insert the 8 AA batteries that are included into the transmitter.
2. Turn the switch on to ensure that the batteries have been installed correctly. The LED’s on the transmitter should glow brightly.

If during operation the transmitter makes a repeated “beep” sound, it is your warning that it is time to replace the transmitter batteries, and you should land your plane immediately.

## Step 2 CHARGING THE AIRCRAFT BATTERY

Your F-27C Stryker comes with a DC balancing charger and 3S Li-Po battery. You must charge the included Li-Po battery pack with a Li-Po specific charger only (such as the included charger). Never leave the battery and charger unattended during the charge process. Failure to follow the instructions properly could result in a fire. When charging, make certain the battery is on a heat-resistant surface.

**DC Li-Po Balancing Charger Features:**

- Charges 2- to 3-cell lithium polymer battery packs
- Variable charge rates from 300mAh–2A
- Automatically detects incorrect cell count selection
- Simple single push-button operation
- LED charge status indicator
- LED cell balance indicator
- Audible beeper indicates power and charge status
- Cigarette lighter input cord

**Specifications**

- Input power: 12V DC, 3A
- Charges 2- to 3-cell Li-Po packs with minimum capacity of 300mAh
- Variable charge rates from 300mAh to 2 amps

**3S 11.1V 2200mAh Li-Po Battery Pack**

The ParkZone 3S Li-Po battery pack features a balancing lead that allows you to more safely charge your battery pack when used with the included ParkZone Li-Po balancing charger.

**To Complete the Charging Process**

1. Attach the input cord of the charger to the appropriate power supply (12V automobile cigarette lighter), or use the HBZ6513 and attach to 12V AC power supply. Once your charger has been correctly powered up, there will be an approximate 3-second delay and then you will hear an audible “beep” and the green (ready) LED will flash.
2. Refer to the chart below to select the appropriate charge rates:

BATTERY CAPACITY	MAX. CHARGE RATE
300–400mAh	300mAh
500–1000mAh	500mAh
1000–1500mAh	1A
1500–2000mAh	1.5A
2000mAh +	2.0A

**Warning:** Selecting a charge rate higher than 1 x battery capacity may cause a fire!

3. Select the proper number of cells that you will be charging, either 2 or 3 cells.
4. Locate the safety charge lead on the battery pack. The charge lead of a 3-cell Li-Po battery will plug into the larger 4-pin port on the bottom right of the charger. A 2-cell pack will need to plug into the 3-pin port on bottom left of the charger. Once the battery is properly plugged into the correct port, it will beep 3 times if it is a 3-cell, and twice if it is a 2-cell pack. Once this is done, you are ready to proceed to charge the battery pack.
5. Push the start button to begin the charging process. Once this is done, the charger will make an audible beep that matches the cell count, and then the red (charge) LED will begin to flash. Do not adjust the current once the charger has begun to charge.

**Note:** At times, the green LED may also flash during the charging process, indicating that the charger is balancing one or more of the cells at the same time it is charging the battery pack. When this is occurring, the red and green LED’s will both be flashing. It will not always be necessary for the cells to be balanced.

6. When the battery pack is fully charged, you will hear an audible beep for about 3 seconds, and the green LED will be solid. The LED will remain solid until the battery pack is unplugged from the charger. Always unplug the battery from the charger immediately upon completion. Failure to do so could cause a fire.

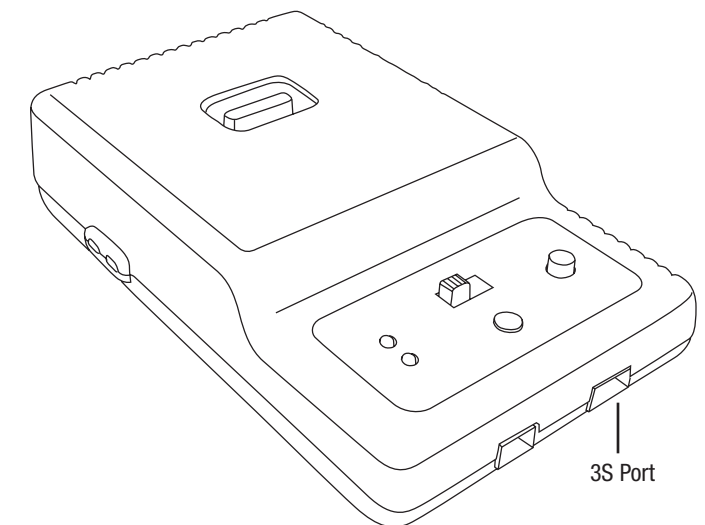

### Step 3

#### ATTACHING THE NOSE

1. Locate the nose inside the box.
2. Trial fit the nose without peeling away the paper covering the tape. This will give you a good idea as to what the fit will be.
3. Peel the paper off the tape and carefully attach the nose.
4. To add support, apply the included decals to the side and bottom of the nose/fuselage

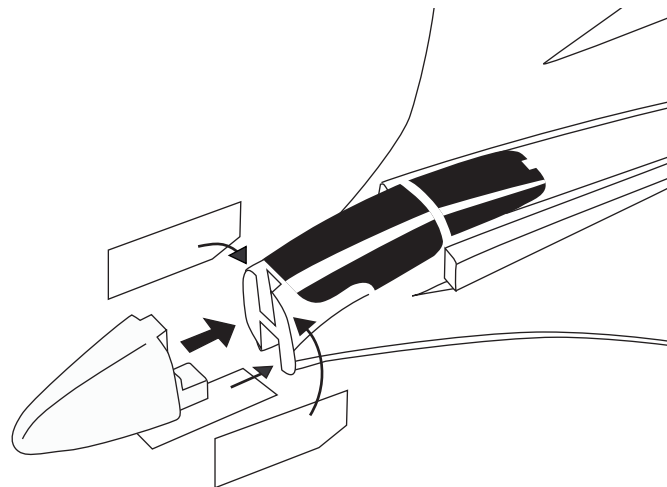

### Step 4

#### ATTACHING THE VERTICAL FINS

1. Locate both fins from box.
2. Slide the fins into the slots on the fuselage. The leading edge of the fin should fit under the retainer that is already secured in the fuselage.
3. Confirm that the fit is tight and both fins are secured properly.

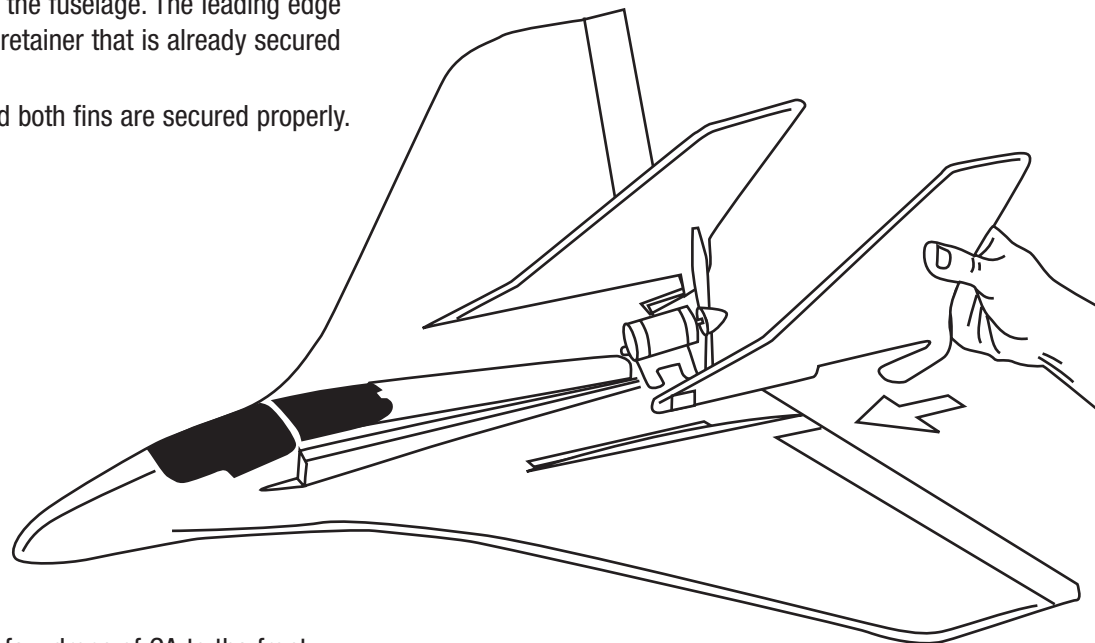

**Note:** It may be helpful to add a few drops of CA to the front tips of the vertical stabs in order to keep them in place while flying your F-27C Stryker. There is rubber double-sided tape on the front of each one, but over time, and despite a tight tension fit when you slide the fins on the first time, they can lose their sticking power. At speeds exceeding 80 mph, it is good, for your safety and the safety of your plane, to add CA to ensure they will stay in place.

### Step 5

#### E-FLITE 25-AMP ESC

Your F-27C Stryker comes out of the box with the E-flite 25-amp brushless ESC. This controller has been designed for use in radio control aircraft and is designed to support motor currents up to 25 amps continuous, and up to 4 micro servos with a 2- to 3-cell Li-Po battery. It is suitable to use with most radio brands. The E-flite 25A ESC comes in an impressive plastic case with exposed, finned heat sinks for both of the motor drive mosfets and, unlike many controllers, there is also a finned heat sink fitted to the BEC regulators to give a more reliable and more powerful power supply to the servos. If you intend to fly your F-27C Stryker stock, then there is no need to program your ESC. It comes installed with the default settings. If you intend to re-program the ESC, we strongly recommend removing the propeller first in order to avoid the propeller from spinning if the motor is accidentally engaged.

**Note:** ALWAYS assume the motor and the propeller are live. ALWAYS keep clear of the propeller at all times. The high rpm of the brushless motor can cause severe injury.

#### E-flite 25-amp ESC Features:

- Two soft cut settings (for 2- and 3-cell Li-Po battery packs)
- 70% Smart Cut feature
- Brake option
- Timing options for up to 4-pole inrunner and 4-pole outrunner motors
- 2 setting options for the throttle input range

#### Using Your E-flite 25-Amp Brushless Controller:

The E-flite 25A controller is very simple to use and, for safety, will not arm the motor until the throttle stick has been held in the Idle/Off position for more than 1 second. The controller will tell you what setting you have for the soft cut voltage every time you plug in the battery by first making a low, long beep to show startup. Then, it makes 2 or 3 medium length, mid-tone beeps to indicate the cell count (or 7 beeps if 70% Smart Cut is selected), helping you to check the setting before every flight.

To prepare for flight, you should first turn on your transmitter and ensure the throttle is set to the Idle/Off position. Next, plug in the flight pack to the speed control and listen for the tones to indicate soft-cut voltage. After the controller has indicated the cell count, the controller will make one set of 3 medium length, rising tones to tell you it is armed and ready to fly, or 2 sets of fast rising tones if you are entering the programming mode.

For your own safety, and the safety of others, you should always treat the motor and propeller as though they are “live” and dangerous, remembering the motor could start at any time. Keep any body parts, clothing and tools clear of the propeller arc. Never leave the battery connected when you are not flying the aircraft. Always remove the battery pack from the model before charging the battery, and when finished flying.

#### Programming:

The E-flite 25-amp programming sequence is designed to be very simple and intuitive. It is a simple menu system that should be very easy to learn and remember.

**Stick up = Full Throttle**

**Stick down = Idle**

#### Default Setup for E-flite 25-amp ESC:

- 3S auto cutoff
- Brake inactive
- 4-pole and greater timing
- Auto setting throttle input range

#### Programming Mode:

1. With the battery disconnected from the controller, and the transmitter turned on, first move the throttle stick to the full power position. Leave it in this position and then connect the battery to the controller.
2. Wait for 5 seconds, and the ESC will give two sets of fast ringing tones to indicate you have successfully entered the programming mode.
3. Once you hear these tones, move the stick to center, and the controller will beep 1 time, indicating you are at menu item number 1.
4. The controller will now wait 5 seconds for you to make your selection, move the stick to Full Throttle for “Yes,” or to Idle for “No.”
5. When you have made a valid selection, the control will beep once with a lower tone and then you can move the stick back to center for the next menu item (2 beeps, 3 beeps and so on). If you do not make a selection within 5 seconds, the controller will move to the next menu item.
6. Please note that you do not need to program every menu item. You can simply exit the programming mode after you have made the required selections by:
  - a. Moving the throttle stick to idle, after making your selection.
  - b. Leaving it in the idle position if you made no selection, for approximately 8 seconds, until you hear one set of 3 medium length rising tones that indicate the controller has armed the motor; or
  - c. By simply unplugging the battery.

## Step 5 *continued*

### Menu Item Selections:

The menu items and choices are as below, where “Yes” means Full Throttle and “No” means Idle.

#### Menu Item 1: Cell Count

Stick up - 3S Li-Po soft cut (default)  
Stick down - 2 cells Ni-Cd or Ni-MH and our exclusive 70% Smart Cut. (See below for more information).

To access the 70% Smart Cut option, leave the stick at full throttle for 7 seconds while in menu item 1, until 7 beeps are heard, then continue through the program normally. This option will activate the soft cut at 70% of startup voltage. For example, if your pack measures 10.0 volts at startup, then the soft cut will occur at 7 volts. The Smart Cut option will check the startup voltage every time you plug the controller in, so beware of using partially-charged packs, as the system cannot protect your Li-Po batteries if you are using Smart Cut and connect a partially-charged pack.

**Note:** The default setting is 3-cell auto cutoff (3.05 volts per cell). You will know that your battery pack has reached auto cutoff when you hear the motor “whine/pulse” repeatedly.

#### Menu Item 2: Brake

Stick up - Brake inactive (default)  
Stick down - Brake active

This option gives you the choice to force the propeller to stop during flight or allow it to windmill. Use the brake option for gliders.

#### Menu Item 3: Timing

Stick up - 4-pole and greater timing mode (default)  
Stick down - 2-pole motors

Refer to your motor specifications to confirm the number of poles.

#### Menu Item 4: Input Range

Stick up - Throttle range 1.1mS to 1.9mS  
Stick down - Auto set (default)

This option allows all the different radios on the market to work with the F-27C Stryker. Most radios work well with the auto set option, but some radios have a wider output range and may give a more linear response with the 1.1- to 1.9-mS range. If you feel there is too much “dead” area in the stick movement near full throttle, try adjusting the end points in your radio or change to the wider input range. Beware that if these settings are not correct, it may be impossible to arm the controller. If this happens, return the input range setting to the default auto-learning setting. The auto-setting option learns the minimum position of your throttle (between 1.1 and 1.3mS), stores this value at each start-up, and then adds a value of 0.6mS for the full throttle setting.

#### Error Codes:

The controller will beep continuously if the input voltage is below the soft cut voltage (beep..beep..beep) when the battery is connected. If you have trouble arming the controller, enter the programming mode and try the auto setting in menu item 4 to see if it helps fix your problem.. (If it is a computer radio, you may alternatively increase your ATV (endpoint) percentages).

**Note:** If you reverse the polarity of the ESC, you will destroy it. Do not allow the ESC to contract any moisture.

When flying in hot weather, we recommend checking on the condition of the ESC, battery, and motor after each flight. You should strongly consider letting the electronic components cool between flights. We also recommend throttle management. It is not recommended that you fly an entire flight at full throttle. If this is done, it is possible to cause permanent damage to your motor, battery, and ESC.

For more information regarding your E-flite 25A ESC please visit [www.E-fliteRC.com](http://www.E-fliteRC.com).

## Step 6 RECEIVER INFORMATION

The following are the channels programmed into the receiver:

**Ch.1: Throttle (ESC)**

**Ch.2: Elevator (left servo)**

**Ch.3: Aileron (R) (right servo)**

Ch.4: Aileron (L)

Ch.5: Rudder

Ch.6: Aux 1

The channels in **bold italics** are the channels that are used in the stock setup of the F-27C.

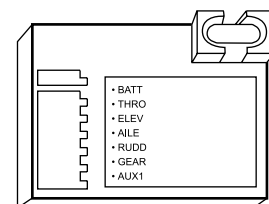

Jumper Out

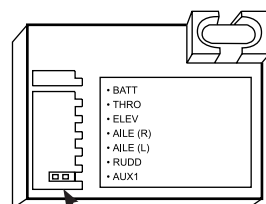

Jumper In

\*Activates dual rates (stock)

## Step 7 MOTOR AND CG INFORMATION

### ParkZone 6-pole 1880Kv Brushless Motor

Your F-27C Stryker is powered by ParkZone’s 6-pole 1880Kv brushless motor, which is installed at the factory, and a 6 x 4 propeller. The 6 x 4 propeller, along with the motor, was chosen to create the correct balance of speed and torque and we do not recommend changing propeller sizes.

**Warning:** Changing the propeller size could increase the current draw and may cause damage to the motor, ESC and battery pack.

### Center of Gravity

The center of gravity (CG) is set at the factory based on using the included battery. As long you insert the battery in the provided battery saddle that is molded into the foam, this CG should be accurate. The 3S Li-Po battery should fit snugly into the foam saddle.

For your reference, the CG sits approximately 6 inches (15.25cm) in front of the trailing edge of the elevons. There are molded round holes on each side of the finger holds on the bottom of the plane that indicate the spot where the CG is located.

### Aileron and Elevator throws:

The recommended throws for low rate are approximately:

Ailerons: +/- 7/16 inches (11mm)

Elevator: +/- 3/8 inches (9mm)

### The recommended throws for high rate are approximately:

Ailerons: +/- 5/8 inches (16mm)

Elevator: +/- 1/2 inches (12mm)

## Step 8 CONTROL TEST

When you are looking from the tail of the aircraft toward the nose, and you give right aileron command, the right elevon should deflect upward, while the left deflects downward. The opposite should happen when you give left aileron command, the left elevon will go up and the right elevon will go down.

When pulling the elevator stick back (down), the elevons should both deflect upward. Conversely, when pushing forward (up), the elevons should both deflect downward.

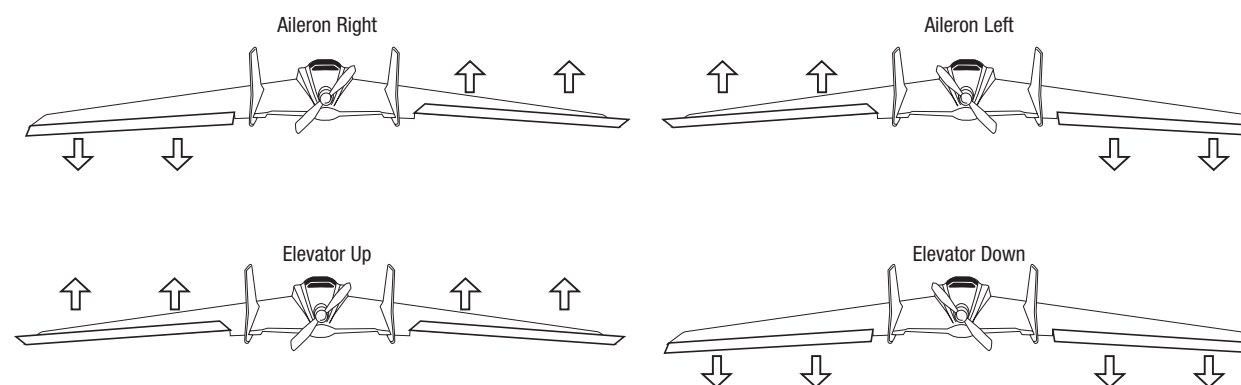

### Jumper In

Your F-27C Stryker receiver comes with a jumper installed into the sixth port (Aux 1) of the receiver. When this jumper is installed, the switch at the top right of the transmitter will function as a dual rate switch.

## Step 9

### RANGE CHECKING YOUR RADIO SYSTEM

Prior to each flight, range check the radio system to make certain everything is functioning correctly.

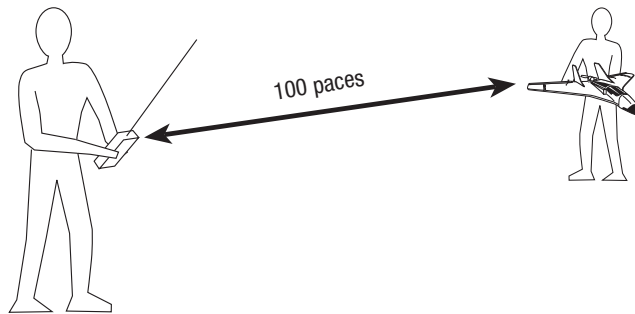

- Make certain no one is using the channel that you will be flying on.
- Always make sure the transmitter is on prior to plugging in the flight battery, and that when you have finished flying, the transmitter is turned off after the battery has been unplugged.
- Have someone help you with this. One person needs to carefully hold the aircraft while the other walks approximately 100 feet (30 meters) away, with the radio on and the motor running. Make certain the person holding the plane stays clear of the propeller.
- Make certain the aircraft is responding correctly to all input. If this is not the case, **DO NOT FLY!** Call the Horizon Hobby Product Support Team at 1-877-504-0233.
- Always make sure all controls are functioning per the transmitter input.
- Always make sure you have fully charged transmitter batteries.

## FUTURE RC FLIGHT

Thank you for buying this F-27C Stryker. We are sure you will have an amazing time flying it, and hope that you will consider buying the many other types of planes that are available from ParkZone. Please don't hesitate to give us a call if you have any questions. Our product support team is available to help you enjoy your flying experience. They can be reached toll-free at 1-877-504-0233.

Sincerely,  
The ParkZone Team

## Step 10

### FLYING YOUR F-27C STRYKER

We've knocked this one out of the park! Choose a very large open space, or an AMA sanctioned flying field, to fly your F-27C Stryker. **DO NOT** fly at a location such as a public park or sports field, even if this is where you typically have flown your park flyers. This airplane can fly at speeds exceeding 80 mph (129k/h), so make sure there are no people that may be endangered. As always, avoid flying where your view may become obstructed, or where there are buildings, trees, cars, or other objects that may jeopardize the success of your flight. Always follow local ordinances.

Before flying, always communicate the frequency at which you intend to fly to other RC pilots around you, and make sure other pilots are not using that channel.

## Step 11

### LAUNCHING AND LANDING

1. Always launch your aircraft directly into the wind, with a very slight upward angle.
2. We recommend launching with power off, and then adding between 60% and full throttle. This is due to the fact that the F-27C Stryker has a pusher propeller.
3. After several minutes of flying, and when you begin to feel the power decreasing, it is time to land.
4. Line up the aircraft directly into the wind when landing, making sure you land with no power to the motor. This will avoid causing damage to the prop, motor, and other components of the plane.

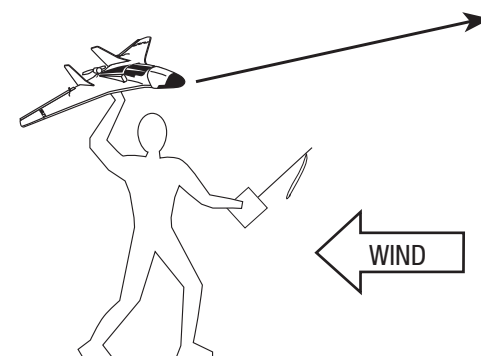

# Warranty and Follow-Up Procedures

## Limited Warranty Period

Horizon Hobby, Inc. guarantees this product to be free from defects in both material and workmanship at the date of purchase.

## Limited Warranty & Limits of Liability

Pursuant to this Limited Warranty, Horizon Hobby, Inc. will, at its option, (i) repair or (ii) replace, any product determined by Horizon Hobby, Inc. to be defective. In the event of a defect, these are your exclusive remedies.

This warranty does not cover cosmetic damage or damage due to acts of God, accident, misuse, abuse, negligence, commercial use, or modification of or to any part of the product. This warranty does not cover damage due to improper installation, operation, maintenance, or attempted repair by anyone other than an authorized Horizon Hobby, Inc. service center. This warranty is limited to the original purchaser and is not transferable. In no case shall Horizon Hobby's liability exceed the original cost of the purchased product and will not cover consequential, incidental or collateral damage. Horizon Hobby, Inc. reserves the right to inspect any and all equipment involved in a warranty claim. Repair or replacement decisions are at the sole discretion of Horizon Hobby, Inc. Further, Horizon Hobby reserves the right to change or modify this warranty without notice.

REPAIR OR REPLACEMENT AS PROVIDED UNDER THIS WARRANTY IS THE EXCLUSIVE REMEDY OF THE CONSUMER. HORIZON HOBBY, INC. SHALL NOT BE LIABLE FOR ANY INCIDENTAL OR CONSEQUENTIAL DAMAGES.

As Horizon Hobby, Inc. has no control over use, setup, final assembly, modification or misuse, no liability shall be assumed nor accepted for any resulting damage or injury. By the act of use, setup or assembly, the user accepts all resulting liability.

If you as the purchaser or user are not prepared to accept the liability associated with the use of this product, you are advised to return this product immediately in new and unused condition to the place of purchase.

## Safety Precautions

This is a sophisticated hobby product and not a toy. It must be operated with caution and common sense and requires some basic mechanical ability. Failure to operate this product in a safe and responsible manner could result in injury or damage to the product or other property. This product is not intended for use by children without direct adult supervision.

The product manual contains instructions for safety, operation and maintenance. It is essential to read and follow all the instructions and warnings in the manual, prior to assembly, setup or use, in order to operate correctly and avoid damage or injury.

## Questions, Assistance, and Repairs

Your local hobby store and/or place of purchase cannot provide

warranty support or repair. Once assembly, setup or use of the product has been started, you must contact Horizon Hobby, Inc. directly. This will enable Horizon to better answer your questions and service you in the event that you may need any assistance.

## Questions or Assistance

For questions or assistance, please direct your email to [productsupport@horizonhobby.com](mailto:productsupport@horizonhobby.com), or call 877.504.0233 toll free to speak to a service technician.

## Inspection or Repairs

If your product needs to be inspected or repaired, please call for a Return Merchandise Authorization (RMA). Pack the product securely using a shipping carton. Please note that original boxes may be included, but are not designed to withstand the rigors of shipping without additional protection. Ship via a carrier that provides tracking and insurance for lost or damaged parcels, as Horizon Hobby, Inc. is not responsible for merchandise until it arrives and is accepted at our facility. Include your complete name, address, phone number where you can be reached during business days, RMA number, and a brief summary of the problem. Be sure your name, address, and RMA number are clearly written on the shipping carton.

## Warranty Inspection and Repairs

To receive warranty service, you must include your original sales receipt verifying the proof-of-purchase date. Providing warranty conditions have been met, your product will be repaired or replaced free of charge. Repair or replacement decisions are at the sole discretion of Horizon Hobby.

## Non-Warranty Repairs

Should your repair not be covered by warranty and the expense exceeds 50% of the retail purchase cost, you will be provided with an estimate advising you of your options. You will be billed for any return freight for non-warranty repairs. Please advise us of your preferred method of payment. Horizon Hobby accepts money orders and cashiers checks, as well as Visa, MasterCard, American Express, and Discover cards. If you choose to pay by credit card, please include your credit card number and expiration date. Any repair left unpaid or unclaimed after 90 days will be considered abandoned and will be disposed of accordingly.

Electronics and engines requiring inspection or repair should be shipped to the following address (freight prepaid):

Horizon Service Center  
4105 Fieldstone Road  
Champaign, Illinois 61822

All other products requiring inspection or repair should be shipped to the following address (freight prepaid):

Horizon Product Support  
4105 Fieldstone Road  
Champaign, Illinois 61822

# Replacement Parts

Item	Description	Retail
PKZ1009	Propeller: F-27C (6 x 4)	\$ 2.99
PKZ1010	Prop Adapter	\$ 4.99
PKZ1030	3S 2200mAh Li-Po Battery	\$ 75.99
PKZ1040	Variable Rate DC Balancing Charger	\$ 34.99
PKZ1061	Mini Servo (3) with Arms, Long Lead	\$ 12.99
PKZ1062	Servo Gear Set (3W and 5W)	\$ 2.49
PKZ4203	Decal Sheet	\$ 5.99
PKZ4206	Instruction Manual	\$ .99
PKZ4213	Complete Hatch Set	\$ 7.99
PKZ4215	Painted Nose	\$ 4.99
PKZ4216	6-pole 1880Kv Brushless Motor	\$ 55.99
EFLA1025	25A Brushless ESC	\$ 52.99
PKZ4233	Elevons with Control Horns	\$ 3.99
PKZ4234	Motor Mount with Hardware	\$ 4.99
PKZ1212	Battery Hatch	\$ 3.49
PKZ1218	Clevis and Pushrod	\$ 2.49
PKZ1220	Vertical Fin Set	\$ 7.99
PKZ1221	Vertical Fin Retainer (2)	\$ 1.59
PKZ4141	Transmitter: (T572) CH 17, 72.130	\$ 32.99
PKZ4142	Transmitter: (T572) CH 19, 72.170	\$ 32.99
PKZ4143	Transmitter: (T572) CH 21, 72.210	\$ 32.99
PKZ4144	Transmitter: (T572) CH 50, 72.790	\$ 32.99
PKZ4145	Transmitter: (T572) CH 52, 72.830	\$ 32.99
PKZ4146	Transmitter: (T572) CH 54, 72.870	\$ 32.99
PKZ4151	Receiver: (RG600T) CH 17, 72.130	\$ 28.99
PKZ4152	Receiver: (RG600T) CH 19, 72.170	\$ 28.99
PKZ4153	Receiver: (RG600T) CH 21, 72.210	\$ 28.99
PKZ4154	Receiver: (RG600T) CH 50, 72.790	\$ 28.99
PKZ4155	Receiver: (RG600T) CH 52, 72.830	\$ 28.99
PKZ4156	Receiver: (RG600T) CH 54, 72.870	\$ 28.99
PKZ4161	FM Crystal Set: Ch 17, 72.130	\$ 9.99
PKZ4162	FM Crystal Set: Ch 19, 72.170	\$ 9.99
PKZ4163	FM Crystal Set: Ch 21, 72.210	\$ 9.99
PKZ4164	FM Crystal Set: Ch 50, 72.790	\$ 9.99
PKZ4165	FM Crystal Set: Ch 52, 72.830	\$ 9.99
PKZ4166	FM Crystal Set: Ch 54, 72.870	\$ 9.99

# Optional Accessories

Item	Description	Retail
PKZ1050	3S 2200mAh Li-Po and 2-3S DC balancing Li-Po Charger	\$119.99
PKZ1051	Non-balancing charge lead adapter (3S to EC3)	\$ 2.99
PKZ1052	Non-balancing charge lead adapter (3S to JST)	\$ 1.99
PKZ1053	Non-balancing charge lead adapter (2S to JST)	\$ 1.99
PKZ1267	Unpainted Fuselage	\$ 19.99
PKZ4275	F-27C Stryker Plug-N-Play	\$179.99

(The PNP is the same as the RTF, but does not include the batteries, radio system or charger.)